

DI 080

S-DIAS Digital Input Module

Instruction Manual

Publisher: SIGMATEK GmbH & Co KG
A-5112 Lamprechtshausen
Tel.: +43/6274/4321
Fax: +43/6274/4321-18
Email: office@sigmatek.at
WWW.SIGMATEK-AUTOMATION.COM

Copyright © 2014
SIGMATEK GmbH & Co KG

Translation of the Original Instructions

All rights reserved. No part of this work may be reproduced, edited using an electronic system, duplicated or distributed in any form (print, photocopy, microfilm or in any other process) without the express permission.

We reserve the right to make changes in the content without notice. The SIGMATEK GmbH & Co KG is not responsible for technical or printing errors in the handbook and assumes no responsibility for damages that occur through use of this handbook.

S-DIAS Digital Input Module

DI 080

with 8 inputs

The S-DIAS digital input module DI 080 is equipped with eight inputs and a +24 V signal for reading the signal states "0" and "1". Input filters are available to suppress noise signals occurring in the signal lines.



Contents

1	Introduction	5
1.1	Target Group/Purpose of this Operating Manual	5
1.2	Important Reference Documentation	5
1.3	Contents of Delivery	5
2	Basic Safety Directives	6
2.1	Symbols Used	6
2.2	Disclaimer	8
2.3	General Safety Directives	9
2.4	Software/Training	10
3	Standards and Directives	11
3.1	Directives	11
3.1.1	EU Conformity Declaration	11
4	Type Plate	12
5	Technical Data	13
5.1	Digital Input Specifications	13
5.2	Electrical Requirements	13
5.3	Miscellaneous	15
5.4	Environmental Conditions	15
6	Mechanical Dimensions	16
7	Connector Layout	17

7.1	Status LEDs.....	17
7.2	Applicable Connectors.....	18
7.3	Label Field	19
8	Wiring	20
8.1	Wiring Example.....	20
8.2	Note	21
9	Assembly/Installation	22
9.1	Check Contents of Delivery	22
9.2	Mounting.....	23
10	Addressing.....	25
11	Supported Cycle Times	26
11.1	Cycle Times below 1 ms (in μ s).....	26
11.2	Cycle Times equal to or higher than 1 ms (in ms).....	26
12	Transport/Storage	27
13	Storage.....	27
14	Maintenance.....	28
14.1	Service	28
14.2	Repair.....	28
15	Disposal	28

16 Hardware Class DI08029

16.1 Interfaces 30

 16.1.1 Clients 30

 16.1.2 Servers 30

 16.1.3 Communication Interfaces 30

16.2 Example 31

1 Introduction

1.1 Target Group/Purpose of this Operating Manual

This operating manual contains all information required for the operation of the product.

This operating manual is intended for:

- Project planners
- Technicians
- Commissioning engineers
- Machine operators
- Maintenance/test technicians

General knowledge of automation technology is required.

Further help and training information, as well as the appropriate accessories can be found on our website www.sigmatek-automation.com.

Our support team is happily available to answer your questions.
Please see our website for our hotline number and business hours.

1.2 Important Reference Documentation

This and additional documents can be downloaded from our website or obtained through support.

1.3 Contents of Delivery

1x DI 080

2 Basic Safety Directives

2.1 Symbols Used

The following symbols are used in the operator documentation for warning and danger messages, as well as informational notes:

DANGER



Danger indicates that death or serious injury **will occur**, if the specified measures are not taken.

⇒ To avoid death or serious injuries, observe all guidelines.

Danger indique une situation dangereuse qui, faute de prendre les mesures adéquates, **entraînera** des blessures graves, voire mortelles.

⇒ Respectez toutes les consignes pour éviter des blessures graves, voire mortelles.

WARNING



Warning indicates that death or serious injury **can** occur, if the specified measures are not taken.

⇒ To avoid death or serious injuries, observe all guidelines.

Avertissement d'une situation dangereuse qui, faute de prendre les mesures adéquates, **entraînera** des blessures graves, voire mortelles.

⇒ Respectez toutes les consignes pour éviter des blessures graves, voire mortelles.

CAUTION



Caution indicates that moderate to slight injury **can** occur, if the specified measures are not taken.

⇒ To avoid moderate to slight injuries, observe all guidelines.

Attention indique une situation dangereuse qui, faute de prendre les mesures adéquates, **peut** entraîner des blessures assez graves ou légères.

⇒ Respectez toutes les consignes pour éviter des blessures graves, voire mortelles.

INFORMATION

**Information**

- ⇒ Provides important information on the product, handling or relevant sections of the documentation, which require attention.
-

2.2 Disclaimer

INFORMATION



The contents of this operating manual were prepared with the greatest care. However, deviations cannot be ruled out. This operating manual is regularly checked and required corrections are included in the subsequent versions. The machine manufacturer is responsible for the proper assembly, as well as device configuration. The machine operator is responsible for safe handling, as well as proper operation.

The current operating manual can be found on our website. If necessary, contact our support.

Subject to technical changes, which improve the performance of the devices. The following operating manual is purely a product description. It does not guarantee properties under the warranty.

Please thoroughly read the corresponding documents and this operating manual before handling a product.

SIGMATEK GmbH & Co KG is not liable for damages caused through, non-compliance with these instructions or applicable regulations.

2.3 General Safety Directives

The Safety Directives in the other sections of this operating manual must be observed. These instructions are visually emphasized by symbols.

INFORMATION



According to EU Directives, the operating manual is a component of a product.

This operating manual must therefore be accessible in the vicinity of the machine since it contains important instructions.

This operating manual should be included in the sale, rental or transfer of the product, or its online availability indicated.

Regarding the requirements for Safety and health connected to the use of machines, the manufacturer must perform a risk assessment in accordance with machine directives 2006/42/EG before introducing a machine to the market.

Operate the unit with devices and accessories approved by SIGMATEK only.

CAUTION

Handle the device with care and do not drop or let fall.

Prevent foreign bodies and fluids from entering the device.

The device must not be opened!

Manipulez l'appareil avec précaution et ne le laissez pas tomber.

Empêchez les corps étrangers et les liquides de pénétrer dans l'appareil.

L'appareil ne doit pas être ouvert!

If the device does not function as intended or has damage that could pose a danger, it must be replaced!

En cas de fonctionnement non conforme ou de dommages pouvant entraîner des risques, l'appareil doit être remplacé!

The module complies with EN 61131-2.

In combination with a facility, the system integrator must comply with EN 60204-1 standards.

For your own safety and that of others, compliance with the environmental conditions is essential.

Le module est conforme à la norme EN 61131-2.

En combinaison avec une équipement, l'intégrateur de système doit respecter la norme EN 60204-1.

Pour votre propre sécurité et celle des autres, le respect des conditions environnementales est essentiel.

2.4 Software/Training

The application is created with the software LASAL CLASS 2 and LASAL SCREEN Editor.

Training for the LASAL development environment, with which the product can be configured, is provided. Information on our training schedule can be found on our website.

3 Standards and Directives

3.1 Directives

The product was constructed in compliance with the following European Union directives and tested for conformity.

3.1.1 EU Conformity Declaration



EU Declaration of Conformity

The product DI 080 conforms to the following European directives:

- **2014/35/EU** Low-voltage Directive
- **2014/30/EU** Electromagnetic Compatibility (EMC Directive)
- **2011/65/EU** “Restricted use of certain hazardous substances in electrical and electronic equipment” (RoHS Directive)

The EU Conformity Declarations are provided on the SIGMATEK website. See Products/Downloads or use the search function and the keyword “EU Declaration of Conformity”.

4 Type Plate

	HW: X.XX
	SW: XX.XX.XXX
	Safety Version: SXX.XX.XX
Serial No.	SIGMATEK GMBH & CO KG Sigmatekstrasse 1 A-5112 LAMPRECHTSHAUSEN
Article Number	Product Name Short Name

Exemplary nameplate (symbol image)

	HW: 1.00
	SW: 01.00.000
	Safety Version: S01.00.00
12345678	SIGMATEK GMBH & CO KG Sigmatekstrasse 1 A-5112 LAMPRECHTSHAUSEN
12-246-133-3	Handbediengerät Wireless HGW 1033-3

HW: Hardware version

SW: Software version

5 Technical Data

5.1 Digital Input Specifications

Number	8	
Input voltage	typically +24 V	maximum +30 V
Signal level (up to HW version 2.20) (up to HW version 3.10, DI 080-E)	low: < +8 V	high: > +14 V
Signal level (starting with HW version 2.30) (starting with HW version 3.20, DI 080-E)	low: < +5 V	high: > +15 V
Input current	3.7 mA at +24 V	
Input delay	typically 5 ms	

5.2 Electrical Requirements

Voltage supply from S-DIAS bus	+5 V	
Current consumption on the S-DIAS bus (+5 V supply) for DI 080 HW1.x to HW3.x	typically 35 mA	maximum 40 mA
Current consumption on the S-DIAS bus (+5 V supply) for DI 080-E HW1.x to HW3.x	typically 35 mA	maximum 40 mA
Current consumption on the S-DIAS bus (+5 V supply) for DI 080-E HW6.x	typically 51 mA	maximum 56 mA

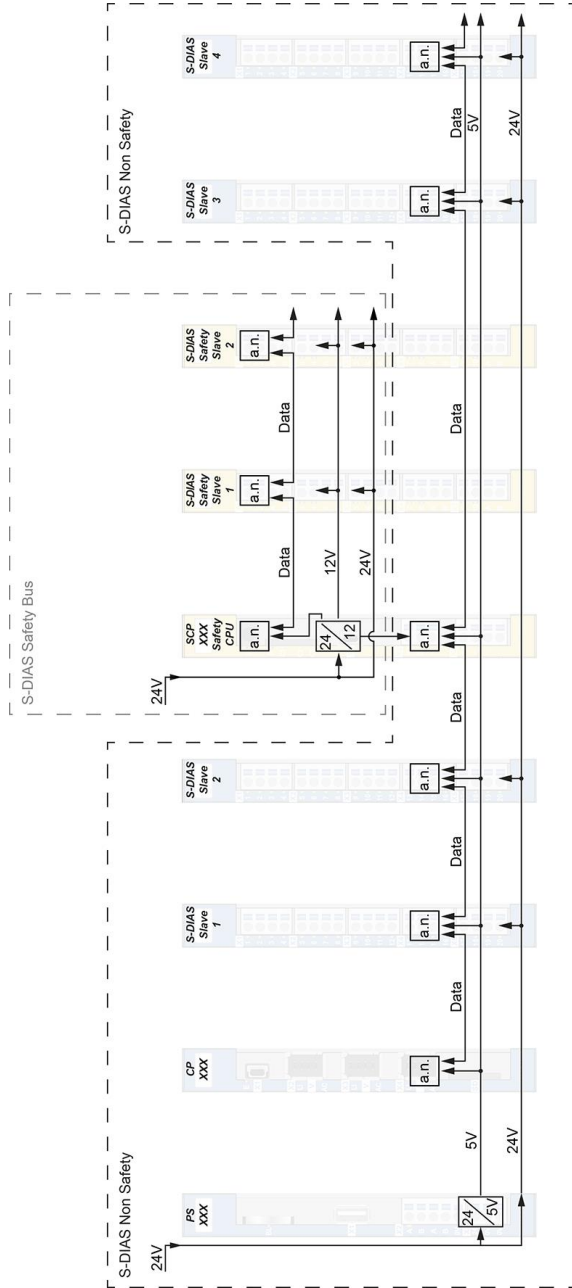

Wiring S-DIAS Safety in S-DIAS System

a.n. = active node

- each S-DIAS module is an active module (active node)
- Safety CPU is connected to the S-DIAS bus (incl. +5 V supply)
- Safety bus is independent and separated from the S-DIAS bus

5.3 Miscellaneous

Article number	20-006-080
Standard	UL 508 (E247993)
Approbations	UL, cUL, CE, UKCA

5.4 Environmental Conditions

Storage temperature	-20 ... +85 °C	
Environmental temperature	0 ... +60 °C	
Humidity	0-95 %, non-condensing	
Installation altitude above sea level	0-2000 m without derating > 2000 m up to a maximum of 5000 m with derating of the maximum environmental temperature by 0.5 °C per 100 m	
Operating conditions	pollution degree 2	
EMC resistance	in accordance with EN 61000-6-2 (industrial area)	
EMC noise generation	in accordance with EN 61000-6-4 (industrial area)	
Vibration resistance	EN 60068-2-6	3.5 mm from 5-8.4 Hz 1 g from 8.4-150 Hz
Shock resistance	EN 60068-2-27	15 g
Protection type	EN 60529	IP20

6 Mechanical Dimensions

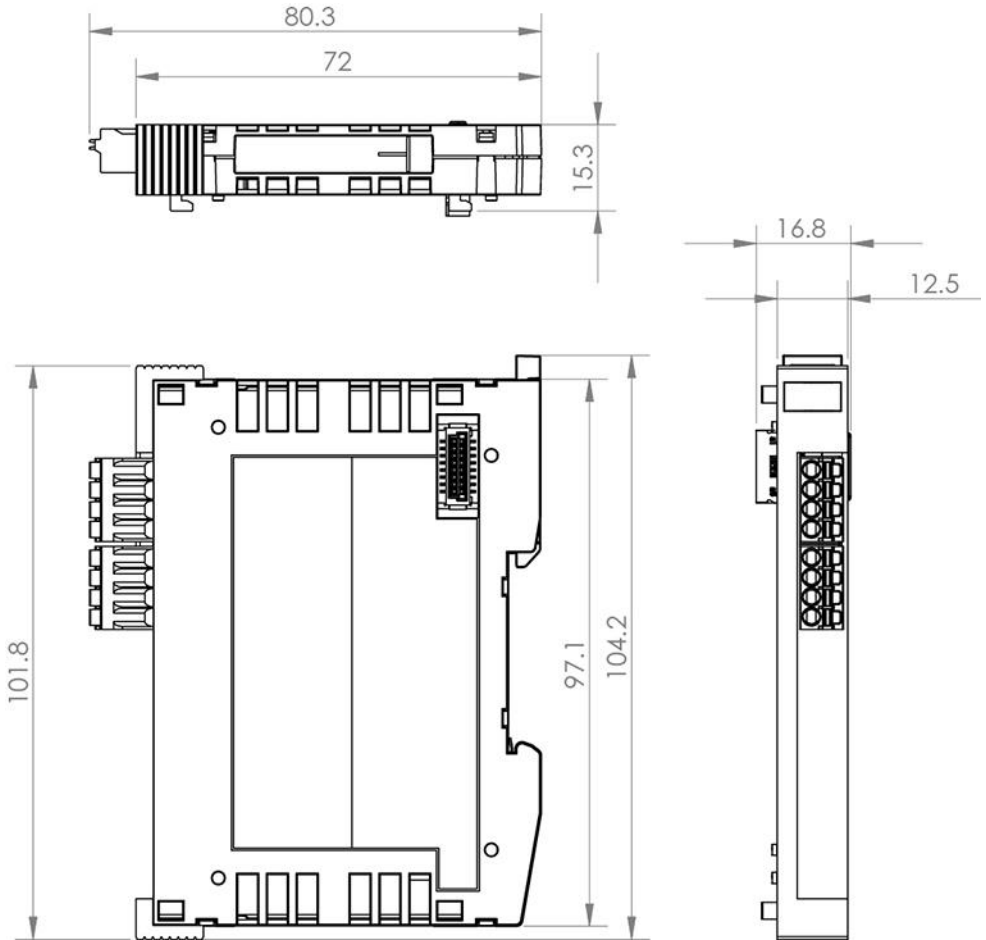

7 Connector Layout

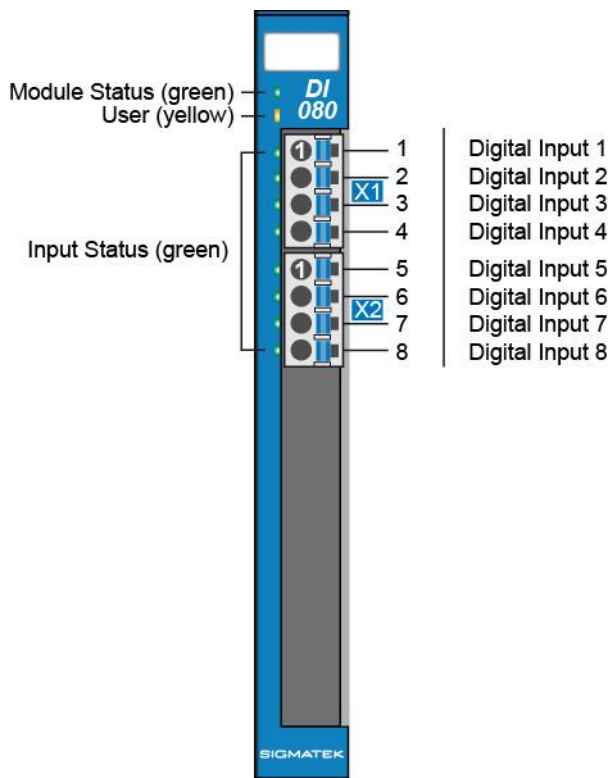

7.1 Status LEDs

Module Status	green	ON	module active
		OFF	no supply available
		BLINKING (5 Hz)	no communication
User	yellow	ON	can be set from the application
		OFF	(e.g. the module LED can be set to blinking through the visualization so that the module is easily found in the control cabinet)
		BLINKING (2 Hz)	
		BLINKING (4 Hz)	
Input Status	green	ON	input ON
		OFF	input OFF

7.2 Applicable Connectors

X1 – X2: Connectors with spring terminals (included in delivery)

The spring terminals are suitable connecting ultrasonically compacted (ultrasonically welded) strands.

Connections:

Stripping length/Sleeve length:	10 mm
Plug-in direction:	parallel to conductor axis or to PCB
Conductor cross section, rigid:	0.2-1.5 mm ²
Conductor cross section, flexible:	0.2-1.5 mm ²
Conductor cross section, ultrasonically compacted:	0.2-1.5 mm ²
Conductor cross section AWG/kcmil:	24-16
Conductor cross section flexible, with ferrule without plastic sleeve:	0.25-1.5 mm ²
Conductor cross section flexible, with ferrule with plastic sleeve:	0.25-0.75 mm ² (ground for reducing d2 of the ferrule)



7.3 Label Field

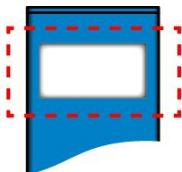

Manufacturer	Weidmüller
Type	MF 10/5 CABUR MC NE WS
Weidmüller article number	1854510000
Compatible printer	Weidmüller
Type	Printjet Advanced 230V
Weidmüller article number	1324380000

8 Wiring

8.1 Wiring Example

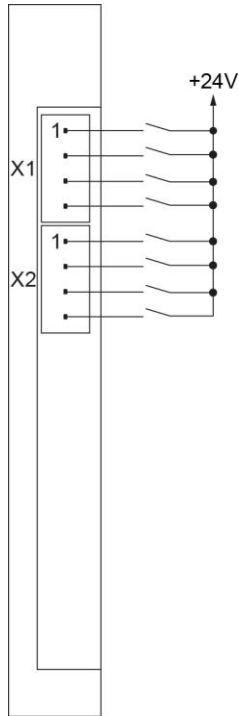

8.2 Note

The input filters, which suppress noise signals, allow operation in harsh environmental conditions. A careful wiring method is also recommended to ensure error-free function.

The following guidelines should be observed:

- Avoid parallel connections between input lines and load-bearing circuits
- Protective circuits for all relays (RC networks or free-wheeling diodes)
- Correct wiring to ground

INFORMATION



Connect the ground bus to the control cabinet.

The S-DIAS module **CANNOT** be connected/disconnected while voltage is applied!

9 Assembly/Installation

9.1 Check Contents of Delivery

Ensure that the contents of the delivery are complete and intact. See chapter 1.3 Contents of Delivery.

INFORMATION



On receipt and before initial use, check the device for damage. If the device is damaged, contact our customer service and do not install the device in your system.

Damaged components can disrupt or damage the system.

9.2 Mounting

The S-DIAS modules are designed for installation into the control cabinet. To mount the modules a DIN-rail is required. The DIN rail must establish a conductive connection with the back wall of the control cabinet. The individual S-DIAS modules are mounted on the DIN rail as a block and secured with latches. The functional ground connection from the module to the DIN rail is made via the grounding clamp on the back of the S-DIAS modules. The modules must be mounted horizontally (module label up) with sufficient clearance between the ventilation slots of the S-DIAS module blocks and nearby components and/or the control cabinet wall. This is necessary for optimal cooling and air circulation, so that proper function up to the maximum operating temperature is ensured.

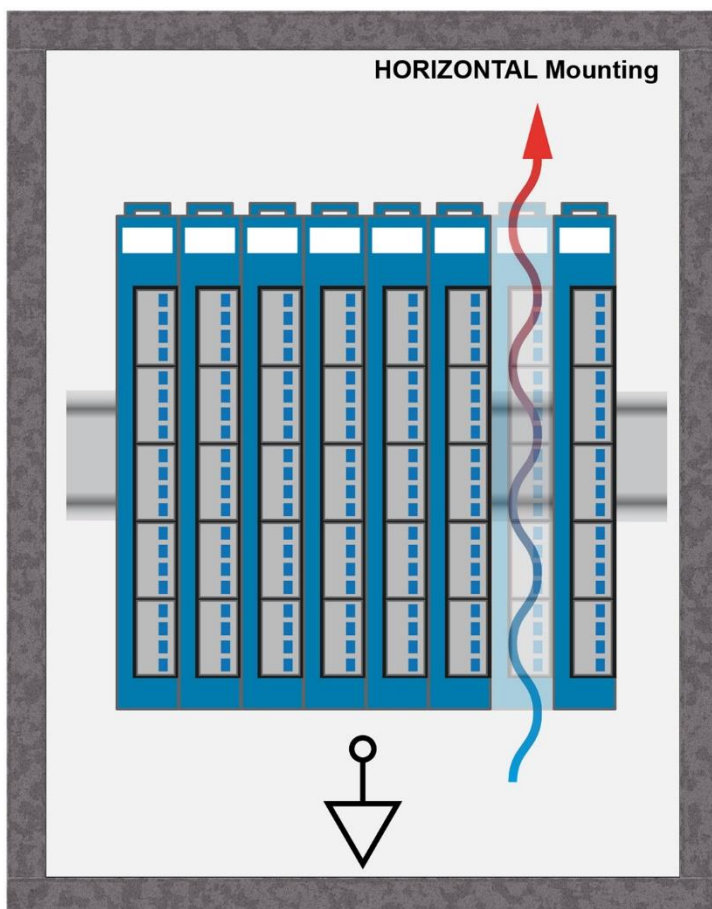

Recommended minimum distances of the S-DIAS modules to the surrounding components or control cabinet wall:

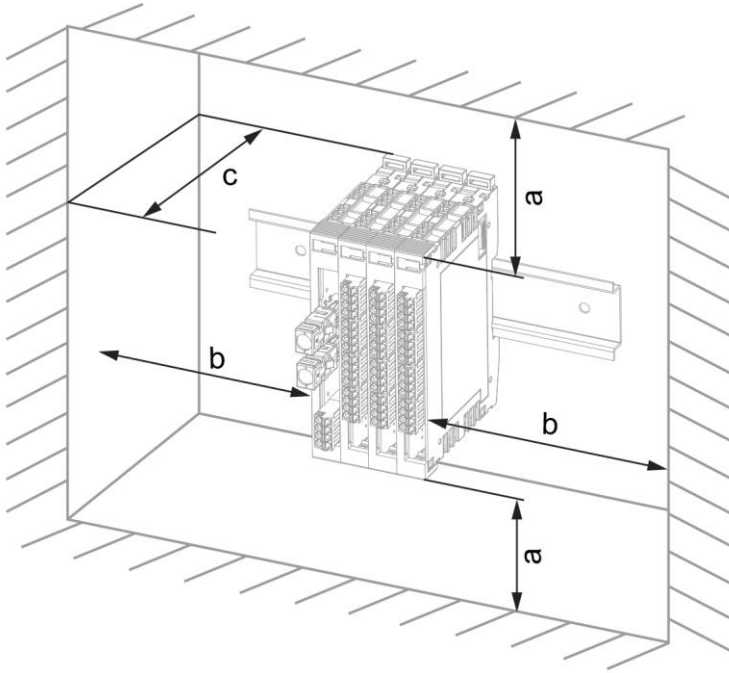

a	b	c
30 mm (1.18")	30 mm (1.18")	100 mm (3.94")

a, b, c ... distances in mm (inches)

10 Addressing

Address (hex)	Size (bytes)	Access Type	Description	Reset value
Memory				
0000	1	r	Input Register Bit 0 Input 1 Bit 1 Input2 ... Bit 7 Input 8	00

11 Supported Cycle Times

11.1 Cycle Times below 1 ms (in μs)

50	100	125	200	250	500
x	x	x	x	x	x

x= supported

11.2 Cycle Times equal to or higher than 1 ms (in ms)

1	2	3	4	5	6	7	8	9	10	11	12	13	14	15	16
x	x	x	x	x	x	x	x	x	x	x	x	x	x	x	x

x= supported

17	18	19	20	21	22	23	24	25	26	27	28	29	30	31	32
x	x	x	x	x	x	x	x	x	x	x	x	x	x	x	x

x= supported

12 Transport/Storage

INFORMATION



This device contains sensitive electronics. During transport and storage, high mechanical stress must therefore be avoided.

For storage and transport, the same values for humidity and vibration as for operation must be maintained!

Temperature and humidity fluctuations may occur during transport. Ensure that no moisture condenses in or on the device, by allowing the device to acclimate to the room temperature while turned off.

When sent, the device should be transported in the original packaging if possible. Otherwise, packaging should be selected that sufficiently protects the product from external mechanical influences. Such as cardboard filled with air cushioning.

13 Storage

INFORMATION



When not in use, store the operating panel according to the storage conditions. See chapter 12.

During storage, ensure that all protective covers (if available) are placed correctly, so that no contamination, foreign bodies or fluids enter the device.

14 Maintenance

INFORMATION



During maintenance as well as servicing, observe the safety instructions from chapter 2 Basic Safety Directives.

14.1 Service

This product was constructed for low-maintenance operation.

14.2 Repair

INFORMATION



In the event of a defect/repair, send the device with a detailed error description to the address listed at the beginning of this document.

For transport conditions, see chapter 12 Transport/Storage.

15 Disposal

INFORMATION



Should you need to dispose of the device, the national regulations for disposal must be followed.

The device appliance must not be disposed of as household waste.



16 Hardware Class DI080

Hardware Class DI080 for the S-DIAS DI080 digital input module

```
SDIAS:34, DI080 (DI0801)
[S] Class State (ClassState) <-[]->
[S] Device ID (DeviceID) <-[]->
[S] FPGA Version (FPGAVersion) <-[]->
[S] Hardware Version (HwVersion) <-[]->
[S] Serial Number (SerialNo) <-[]->
[S] Retry Counter (RetryCounter) <-[]->
[O] LED Control (LEDControl) <-[]->
----- Digital Inputs -----
[I] Digital Input 1 (Input1) <-[]->
[I] Digital Input 2 (Input2) <-[]->
[I] Digital Input 3 (Input3) <-[]->
[I] Digital Input 4 (Input4) <-[]->
[I] Digital Input 5 (Input5) <-[]->
[I] Digital Input 6 (Input6) <-[]->
[I] Digital Input 7 (Input7) <-[]->
[I] Digital Input 8 (Input8) <-[]->
[I] Input Byte (InputByte) <-[]->
[ ] ALARM:00, Empty
```

This hardware class is used to control the DI 080 hardware module with 8 digital inputs. More information on the hardware can be found in the module documentation.

16.1 Interfaces

16.1.1 Clients

SdiasIn	The client must be connected to an S-DIAS port, an "SdiasOut"_[x]" server.
Place	The physical location of the hardware module is entered in this client. Up to 64 modules, 0 to 63, can be assigned.
Required	This client is active by default, which means that the S-DIAS hardware module at this position is mandatory for the system and can under no circumstances be disconnected or return an error. Otherwise, the entire hardware deactivated. If the hardware module is missing or removed, an S-DIAS error is triggered. If his client is initialized with 0, the hardware module located in this position is not mandatory. This means that it doesn't have to be available or error-free. However, which components identified as "not required" should be selected with regard to the safety of the system.

16.1.2 Servers

ClassState	This server shows the actual status of the hardware class.								
DeviceID	The device ID of the hardware module is shown in this server.								
FPGAVersion	FPGA version of the module in 16#XY (e.g. 16#10 = version 1.0).								
SerialNo	The serial number of the hardware module is shown in this server.								
RetryCounter	This server increments when a transfer fails.								
LEDControl	With this server, the application LED of the S-DIAS module can be activated to find the module in the network more quickly. The following statuses are possible: <table border="1" data-bbox="403 869 1013 997"> <tr> <td>0</td> <td>LED off</td> </tr> <tr> <td>1</td> <td>LED on</td> </tr> <tr> <td>2</td> <td>blinks slowly</td> </tr> <tr> <td>3</td> <td>blinks rapidly</td> </tr> </table>	0	LED off	1	LED on	2	blinks slowly	3	blinks rapidly
0	LED off								
1	LED on								
2	blinks slowly								
3	blinks rapidly								
Input[1-8]	Status of input 1-8								
InputByte	In this server, the digital outputs are shown in an 8-bit field. Within this bit field, 0 to 7 are allocated to inputs input1 to input8.								

16.1.3 Communication Interfaces

ALARM	Downlink	With this downlink the corresponding alarm class can be placed via the hardware editor.
--------------	-----------------	---

16.2 Example

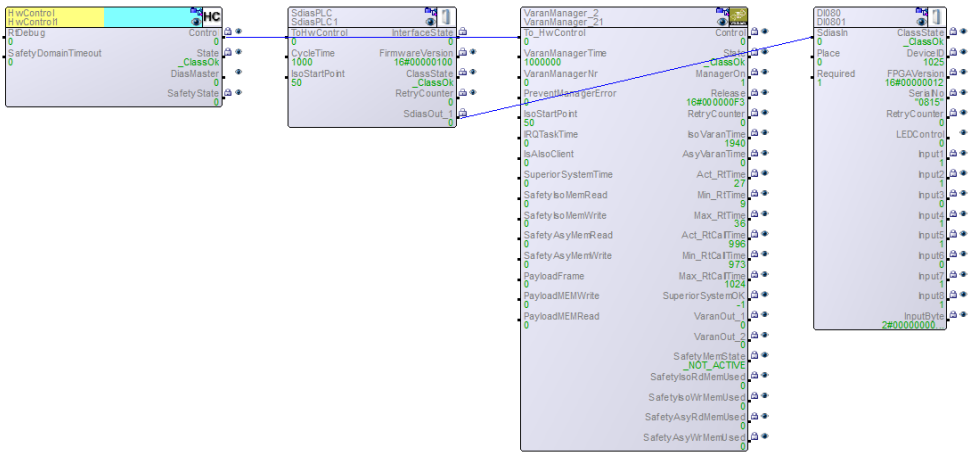

Documentation Changes

Change date	Affected page(s)	Chapter	Note
01.04.2014	3	1.3 Miscellaneous	UL added
	9	5 Mounting	Text updated
30.01.2015	8	4.2 Note	Added note concerning connecting the S-DIAS module while voltage is applied
26.03.2016	7	3.2 Applicable Connectors	Added connections
28.04.2016	12	5 Mounting	Graphics distances
17.08.2017	5	1.4 Environmental Conditions	Added operating conditions
	8	3.2 Applicable Connectors	Added sleeve length Added info regarding ultrasonically welded strands
18.10.2017	9	3.3 Label Field	Added chapter
	13	5 Mounting	Graphic replaced
14.11.2019		7 Supported Cycle Times	Chapter added
28.02.2020	15	7 Supported Cycle Times	Text adapted
08.09.2020	17	8 Hardware Class DI080	Chapter added
04.11.2020	13	5 Mounting	Expansion functional ground connection
24.08.2021	4	1.1 Digital Input Specifications	Signal level and Switching threshold
30.08.2021	4	1.1 Digital Input Specifications	DI 080-E Signal level
13.09.2021	4	1.2 Electrical Requirements	Current consumption changed
05.10.2021	4	1.2 Electrical Requirements	HW version -E added
06.12.2022	6	1.3 Miscellaneous	UKCA conformity
26.07.2023		Document	General chapters added, design