

PCV 522

VARAN Manager PCI Insertable Module

Publisher: SIGMATEK GmbH & Co KG
A-5112 Lamprechtshausen
Tel.: 06274/4321
Fax: 06274/4321-18
Email: office@sigmatek.at
WWW.SIGMATEK-AUTOMATION.COM

Copyright © 2014
SIGMATEK GmbH & Co KG

Translation from German

All rights reserved. No part of this work may be reproduced, edited using an electronic system, duplicated or distributed in any form (print, photocopy, microfilm or in any other process) without the express permission.

We reserve the right to make changes in the content without notice. The SIGMATEK GmbH & Co KG is not responsible for technical or printing errors in the handbook and assumes no responsibility for damages that occur through use of this handbook.

VARAN Manager PCI Insertable Module

PCV 522

Versatile Automation Random Access Network

The insertable PVC 522 PCI module can be used in any standard PC. The module provides a VARAN Manager and is used as an interface between the PC and VARAN bus. With the PCV 522, VARAN modules can be controlled directly from the PC.

In addition, the PCV 522 has a battery-buffered SRAM as well as a status LED.



Contents

1	Technical Data	3
1.1	Performance Data	3
1.2	Electrical Requirements	3
1.3	Miscellaneous	3
1.4	Environmental Conditions	4
2	Mechanical Dimensions	5
3	Connector Layout	6
3.1	Status LED	7
3.2	Connectors	7
3.3	Applicable Connectors	7
4	Buffer Battery	8
4.1	Exchanging the Battery	9
5	Recommended Shielding for VARAN	10
5.1	Wiring from the Control Cabinet to an External VARAN component	11
5.2	Wiring Outside of the Control Cabinet	12
5.3	Shielding for Wiring Within the Control Cabinet	13
5.4	Connecting Noise-Generating Components	14
5.5	Shielding Between Two Control Cabinets	15

1 Technical Data

1.1 Performance Data

PCI bus	32-Bit PCI bus card / 33 MHz Vendor ID: 5112 Device ID: 2200
VARAN bus	2x VARAN Out (Manager) (maximum cable length: 100 m) VARAN Device ID: 1221
Status display	green: RUN
Internal remnant data memory	1024-kbyte SRAM (battery buffered)

1.2 Electrical Requirements

Supply voltage	+5 V DC (from PCI bus)	
Current consumption on the PCI bus (+5 V power supply)	typically 25 mA	maximum 30 mA
Supply voltage	+3.3 V DC (from PCI bus)	
Current consumption on the PCI bus (+3.3 V supply)	typically 250 mA	maximum 300 mA

1.3 Miscellaneous

Article number	01-320-522
Hardware version	1.x
Standard	designed according to UL

1.4 Environmental Conditions

Storage temperature	-20 ... +85 °C	
Operating temperature	0 ... +60 °C	
Humidity	0 - 95 %, non-condensing	
EMV resistance	in accordance with EN 61000-6-2 (industrial area)	
EMC - noise generation	in accordance with EN 61000-6-4 (industrial area)	
Vibration resistance	EN 60068-2-6	3.5 mm from 5 Hz – 8.4 Hz 1 g from 8.4 Hz – 150 Hz
Shock resistance	EN 60068-2-27	15 g
Protection type	EN 60529	IP20

2 Mechanical Dimensions

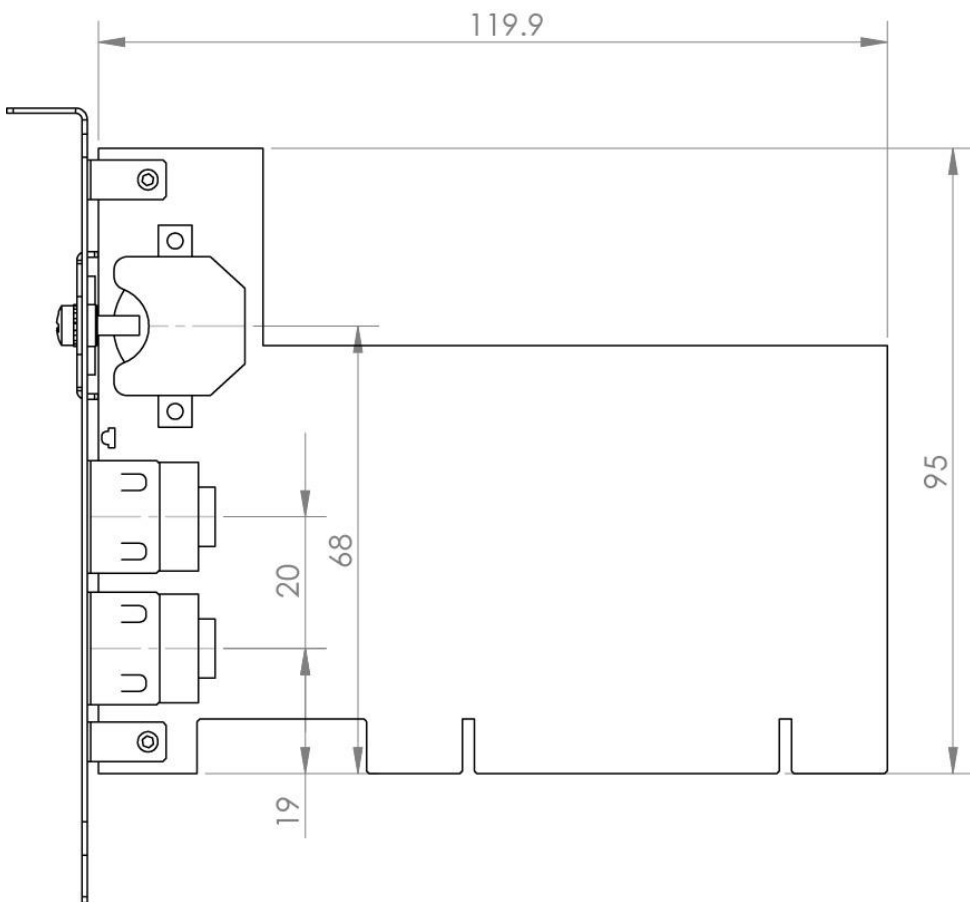

3 Connector Layout

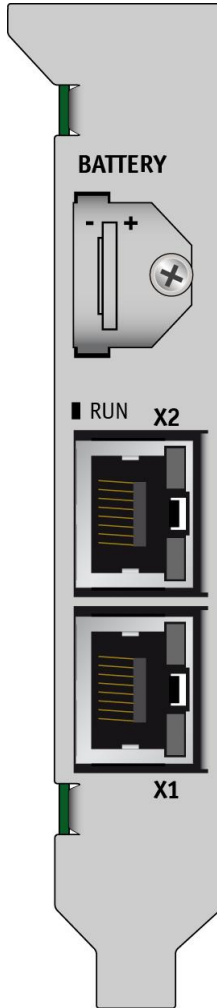

3.1 Status LED

LED RUN	LED Status	Meaning
green	ON	application running
	OFF	during boot-up and in CLI

3.2 Connectors

X1, X2: VARAN Out (RJ45)

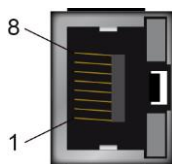

Pin	Function
1	TX/RX+
2	TX/RX-
3	RX/TX+
4 – 5	n.c.
6	RX/TX-
7 – 8	n.c.

LEDs	Function
Yellow	ACTIVE
Green	Link

n.c. = do not use

LED	Color	Description
ACTIVE	Yellow	Lights when data is received over the VARAN bus
Link	Green	Lights when the connection between the two PHYs is established

More information on the VARAN bus can be found in the VARAN bus specifications!

3.3 Applicable Connectors

Connectors:

X1, X2: RJ5 connector (not included in delivery!)

4 Buffer Battery

The exchangeable buffer battery ensures that the SRAM data of the PCV 522 is preserved in the absence of a supply voltage. A lithium battery is installed at the manufacturer.

After delivery of the PVC 522 and storage of one year, the lifespan of the battery reaches 10 years.

We recommend however, that the battery be replaced every 2 years to ensure optimal performance.

Battery order number: **01-690-055**

	MANUFACTURER	DATA
Lithium battery	RENATA	3.0 V / 235 mAh

Use batteries from RENATA with the label CR2032 only!
Warning! Incorrect use of the batteries could result in fire or explosion! Do not recharge, disassemble or throw batteries into fire!

Utilisez seulement des piles de RENATA CR2032! ATTENTION! La pile peut exploser si elle n'est pas manipulée correctement! Ne pas recharger, démonter ou jeter au feu!

When the battery voltage is in between the supervisor circuit thresholds, it may happen that the battery is detected "good" during operation, but "low" after a power cycle. If this happens, it is recommended to replace the battery.

4.1 Exchanging the Battery

1. PC with inserted PCV 522 should be left on for at least 1 minute before changing the battery.
2. Shut down and turn off the PC. Disconnect the power supply.
3. Loosen the mounting screws using a screw-driver (not necessary to remove completely).



4. Lift the cover and rotate it to the side. Using the strap, remove the battery from the holder.



5. The new battery must be inserted with the correct polarity with 5 minutes (see plus pole label).

When exchanging the battery, caution must be taken to avoid a short circuit. Otherwise, a defect can be caused in the terminal!

6. Replace the cover, tighten the mounting screws and apply power to the PC.

5 Recommended Shielding for VARAN

The VARAN real-time Ethernet bus system exhibits a very robust quality in harsh industrial environments. Through the use of IEEE 802.3 standard Ethernet physics, the potentials between an Ethernet line and sending/receiving components are separated. In the event of an error, the VARAN Manager resends messages to a bus participant immediately. The shielding described below is mainly recommended.

For applications in which the bus is operated outside the control cabinet, the correct shielding is required. This is especially important, if due to physical requirements, the bus cables must be placed next to sources of strong electromagnetic noise. It is recommended to avoid placing VARAN bus lines parallel to power cables whenever possible.

SIGMATEK recommends the use of CAT5e industrial Ethernet bus cables.

An S-FTP cable should be used for the shielding. An S-FTP bus is a symmetric, multi-wire cable with unshielded pairs. For the entire shielding, a combination of foil and braiding is used. A non-laminated variant is recommended.

The VARAN cable must be secured at a distance of 20 cm from the connector for protection against vibration!

Le câble VARAN doit être protégé contre les vibrations à moins de 20 cm du connecteur (par exemple à l'aide d'une pince)!

5.1 Wiring from the Control Cabinet to an External VARAN component

If the Ethernet lines are connected from a VARAN component to a VARAN node located outside the control cabinet, the shielding should be placed at the entry point of the control cabinet housing. All noise can then be deflected from the electronic components before reaching the module.

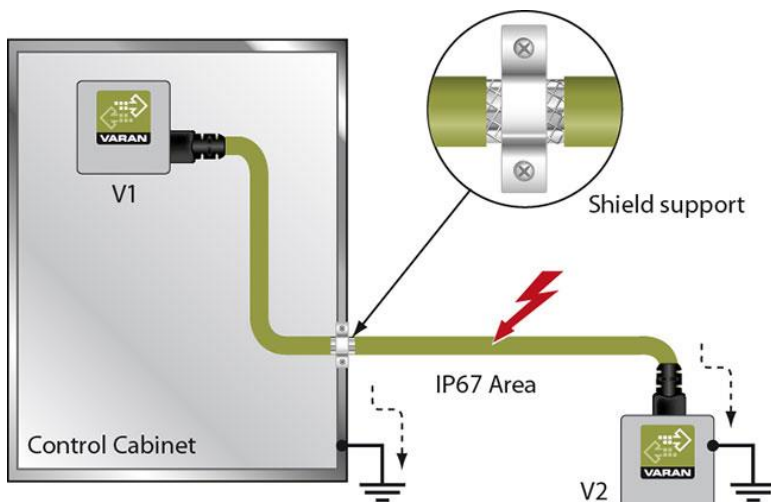

5.2 Wiring Outside of the Control Cabinet

If a VARAN bus line must be connected outside of the control cabinet only, no additional shield support is required. A requirement therefore, is that only IP67 modules and connectors can be used outside the control cabinet. These components are very robust and noise resistant. The shielding for all sockets in IP67 modules is electrically connected internally or over the housing, whereby voltage spikes are not deflected through the electronics.

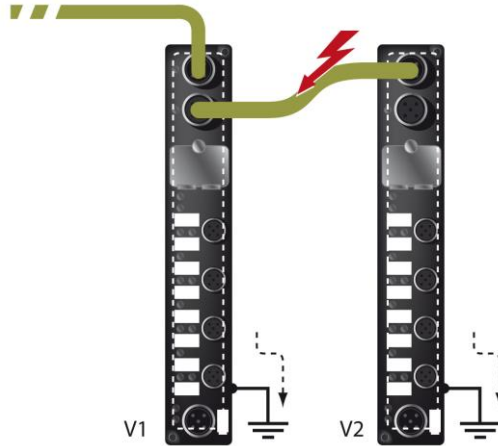

5.3 Shielding for Wiring Within the Control Cabinet

Sources of strong electromagnetic noise located within the control cabinet (drives, Transformers, etc.) can induce interference in a VARAN bus line. Spike voltages are dissipated over the metallic housing of a RJ45 connector. Noise is conducted through the control cabinet housing without further action from the electronic components. To eliminate sources of noise during data transfer, it is recommended that the shielding for all electronic components be connected within the control cabinet.

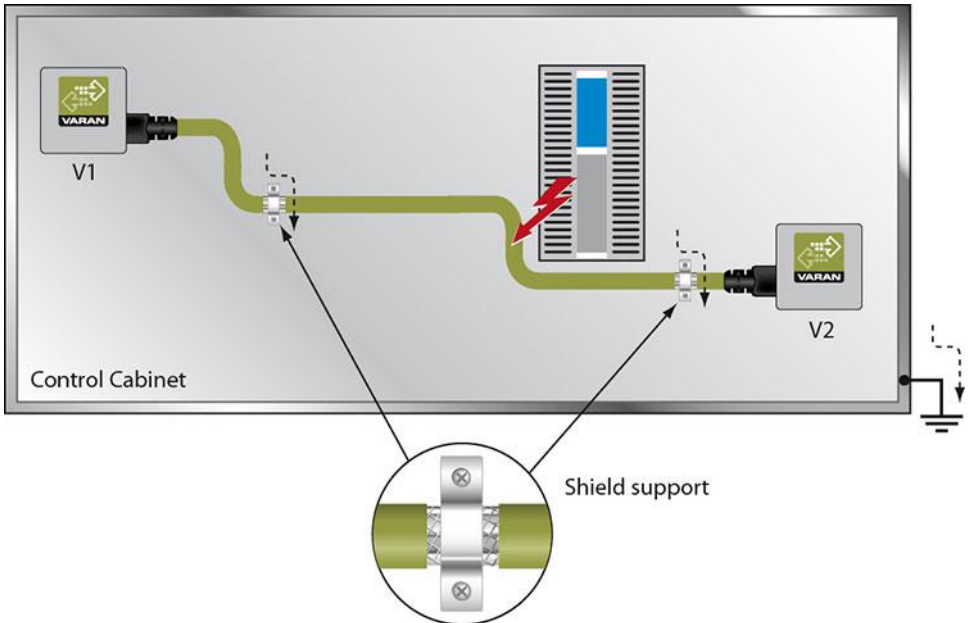

5.4 Connecting Noise-Generating Components

With the connection of power components, which generate strong electromagnetic interference, it is also critical to ensure correct shielding. The shielding should be placed before a power element (or group of power elements).

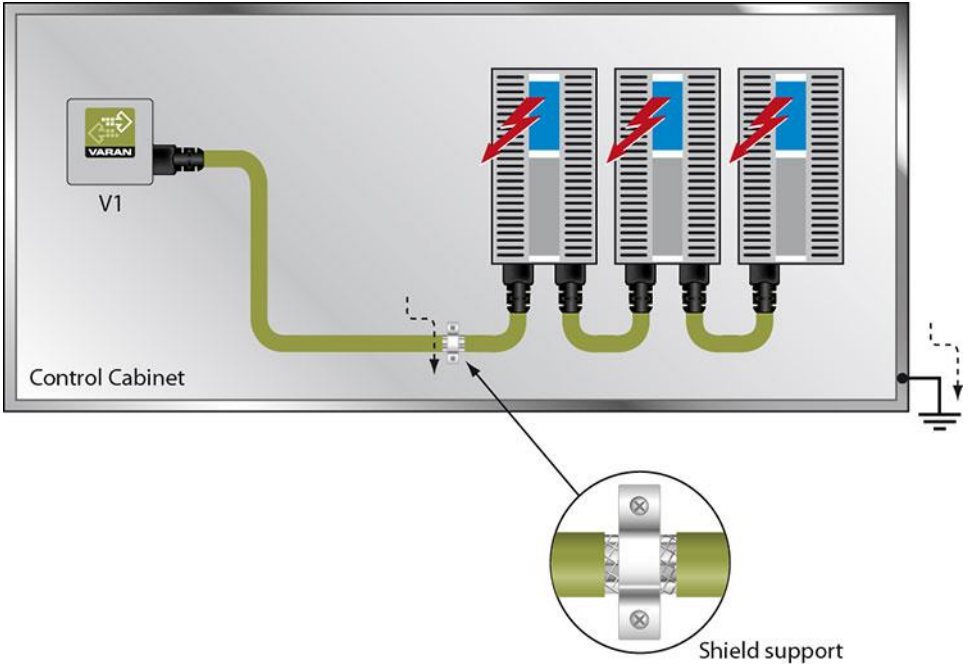

5.5 Shielding Between Two Control Cabinets

If two control cabinets must be connected over a VARAN bus, it is recommended that the shielding be located at the entry points of both cabinets. Noise can be thereby prevented from reaching the electronics within the control cabinet.

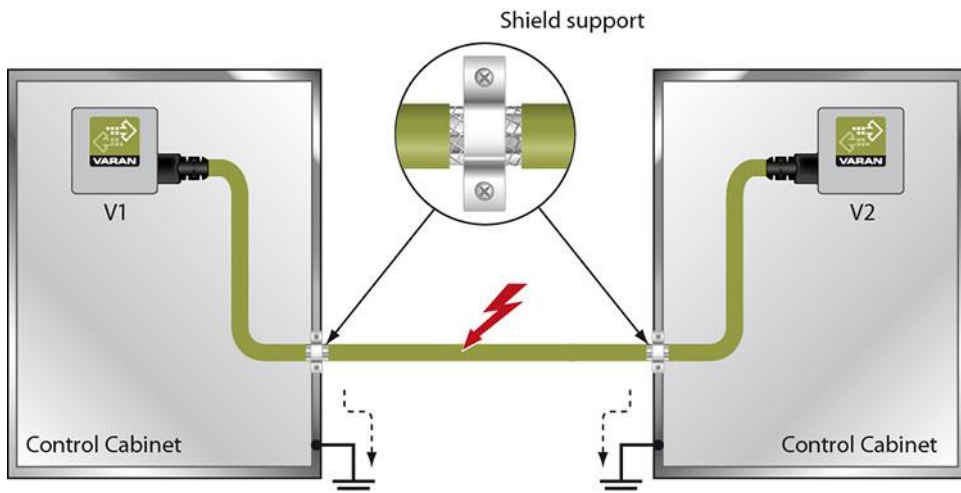

Documentation Changes

Change date	Affected page(s)	Chapter	Note
05.12.2016	8	4 Buffer Battery	Battery monitoring added