

TAE 1244

Build-in Touch Terminal

Instruction Manual

Publisher: SIGMATEK GmbH & Co KG
A-5112 Lamprechtshausen
Tel.: +43/6274/4321
Fax: +43/6274/4321-18
Email: office@sigmatek.at
WWW.SIGMATEK-AUTOMATION.COM

Copyright © 2020
SIGMATEK GmbH & Co KG

Translation of the Original Instructions

All rights reserved. No part of this work may be reproduced, edited using an electronic system, duplicated or distributed in any form (print, photocopy, microfilm or in any other process) without express permission.

We reserve the right to make changes in the content without notice. SIGMATEK GmbH & Co KG is not responsible for technical or printing errors in this handbook and assumes no responsibility for damages that occur through its use.

Build-in Touch Terminal

TAE 1244

The multi-touch operating panel TAE 1244 is used to visualize automated processes. The operation and monitoring of automated procedures are simplified using this display unit. The projective capacitive touch screen is used to enter process data and parameters. The output is shown on a 12.1" color display with LED backlighting.

This module operates with SIGMATEK HMI-LINK generation 2.1 (G2.1). This allows a transmission from the display, as well as USB signals using standard cables (CAT-5e or CAT-6) from a remote PC to a terminal (up to 100 m).

Currently supported: PC 452-K, HMI-Link G2 insert (PC 301-E7) and HMI-Link G2 Box (PC 301-E8). A device equipped with a generation 2.1 SIGMATEK HMI-Link (G2.1) is also required on the PC side; either integrated directly on the PC or as an external expansion box. With the 2 integrated USB connection, external end devices (mouse, keyboard ...) or memory (USB stick) can be connection on the HMI side.



Table of Contents

1 Introduction	5
1.1 Target Group/Purpose of this Operating Manual	5
1.2 Important Reference Documentation	5
1.3 Contents of Delivery	5
2 Basic Safety Directives	6
2.1 Symbols Used	6
2.2 Disclaimer	8
2.3 General Safety Directives	9
3 Standards and Directives	11
3.1 Directives	11
3.1.1 EU Conformity Declaration	11
4 Type Plate	12
5 Technical Data	13
5.1 Performance Data	13
5.2 Electrical Requirements	13
5.3 Display	15
5.4 Control Unit	16
5.5 Minimum Distance between Operating Elements for Multi-touch Applications	17
5.6 Environmental Conditions	18
5.7 Miscellaneous	19
6 Interfaces	20
6.1 Front Connectors	20
6.1.1 X1: Supply (4-pin Phoenix RM 3.5)	20
6.1.2 X2: HMI Remote-IN (HMI-Link G2.1, Industrial Mini I/O)	20
6.1.3 X3: Service	21
6.1.4 X4, X5: USB 2.0 (Type A)	21

6.1.5 X6: Panel Interface Connector	22
6.2 Applicable Connectors	22
6.3 Status Display LEDs	23
7 Mechanical Dimensions	24
8 Assembly/Installation	26
8.1 Check Contents of Delivery	26
8.2 Installation	26
8.3 Mounting Instructions	26
8.3.1 Restricted Space Around Rear Trimming	27
8.3.2 Required Cutout for Mounting the Terminal	28
8.3.3 Mounting Position	29
9 Wiring	30
9.1 Grounding	30
9.2 Shielding	30
9.3 ESD Protection	31
9.4 USB Interface	31
10 Transport/Storage	32
11 Storage	33
12 Maintenance	34
12.1 Cleaning and Disinfecting the Touch Screen	34
12.2 Service	35
12.2.1 Calibrating the Touch Screen	35
12.3 Repair	35
12.4 Position Series Label Sub Device	36
13 Modularity	37
13.1 Removing the PIM from the Touch Panel	37
13.2 Mounting the PIM onto the Touch Panel	38

14 Display „Burn-In“ Effect	39
15 Disposal	40
16 Accessories	41
16.1 Touch Pen	41

1 Introduction

1.1 Target Group/Purpose of this Operating Manual

This operating manual contains all information required for the operation of the product.

This operating manual is intended for:

- Project planners
- Technicians
- Commissioning engineers
- Machine operators
- Maintenance/test technicians

General knowledge of automation technology is required.

Further help and training information, as well as the appropriate accessories can be found on our website www.sigmatek-automation.com.

Our support team is happily available to answer your questions.
Please see our website for our hotline number and business hours.

1.2 Important Reference Documentation

- TP XX61
- PIM 021

This and additional documents can be downloaded from our website or obtained through support.

1.3 Contents of Delivery

1x TAE 1244
8x angle bracket
1x 4-pin Phoenix connector plug
2x M3 TX10 Torx screws

2 Basic Safety Directives

2.1 Symbols Used

The following symbols are used in the operator documentation for warning and danger messages, as well as informational notes.

DANGER



Danger indicates that death or serious injury **will occur**, if the specified measures are not taken.

→ To avoid death or serious injuries, observe all guidelines.

Danger indique une situation dangereuse qui, faute de prendre les mesures adéquates, **entraînera** des blessures graves, voire mortelles.

→ Respectez toutes les consignes pour éviter des blessures graves, voire mortelles.

WARNING



Warning indicates that death or serious injury **can** occur, if the specified measures are not taken.

→ To avoid death or serious injuries, observe all guidelines.

Avertissement d'une situation dangereuse qui, faute de prendre les mesures adéquates, **entraînera** des blessures graves, voire mortelles.

→ Respectez toutes les consignes pour éviter des blessures graves, voire mortelles.

CAUTION

Caution indicates that moderate to slight injury **can** occur, if the specified measures are not taken.

→ To avoid moderate to slight injuries, observe all guidelines.

Attention indique une situation dangereuse qui, faute de prendre les mesures adéquates, **peut** entraîner des blessures assez graves ou légères.

→ Respectez toutes les consignes pour éviter des blessures graves, voire mortelles.

CAUTION

Danger for ESD-sensitive components.

Les signes de danger pour les composants sensibles aux décharges électrostatiques.

INFORMATION**INFORMATION**

→ Provides important information on the product, handling or relevant sections of the documentation, which require particular attention.

2.2 Disclaimer



INFORMATION

The contents of this operating manual were prepared with the greatest care. However, deviations cannot be ruled out. This operating manual is regularly checked and required corrections are included in the subsequent versions. The machine manufacturer is responsible for the proper assembly, as well as device configuration. The machine operator is responsible for safe handling, as well as proper operation.

The current operating manual can be found on our website. If necessary, contact our support.

Subject to technical changes, which improve the performance of the devices. The following operating manual is purely a product description. It does not guarantee properties under the warranty.

Please thoroughly read the corresponding documents and this operating manual before handling a product.

SIGMATEK GmbH & Co KG is not liable for damages caused through, non-compliance with these instructions or applicable regulations.

2.3 General Safety Directives

The Safety Directives in the other sections of this operating manual must be observed. These instructions are visually emphasized by symbols.

INFORMATION



According to EU Directives, the operating manual is a component of a product.

This operating manual must therefore be accessible in the vicinity of the machine since it contains important instructions.

This operating manual should be included in the sale, rental or transfer of the product, or its online availability indicated.

Regarding the requirements for Safety and health connected to the use of machines, the manufacturer must perform a risk assessment in accordance with machine directives 2006/42/EG before introducing a machine to the market.

Operate the unit with devices and accessories approved by SIGMATEK only.

CAUTION

Handle the device with care and do not drop or let fall.
Prevent foreign bodies and fluids from entering the device.
The device must not be opened!

Manipulez l'appareil avec précaution et ne le laissez pas tomber.
Empêchez les corps étrangers et les liquides de pénétrer dans l'appareil.
L'appareil ne doit pas être ouvert!

If the device does not function as intended or has damage that could pose a danger, it must be replaced!

En cas de fonctionnement non conforme ou de dommages pouvant entraîner des risques, l'appareil doit être remplacé !

The module complies with EN 61131-2.
In combination with a facility, the system integrator must comply with EN 60204-1 standards.
For your own safety and that of others, compliance with the environmental conditions is essential.

Le module est conforme à la norme EN 61131-2.
En combinaison avec une équipement, l'intégrateur de système doit respecter la norme EN 60204-1.
Pour votre propre sécurité et celle des autres, le respect des conditions environnementales est essentiel.

3 Standards and Directives

3.1 Directives

The product was constructed in compliance with the following European Union directives and tested for conformity.

3.1.1 EU Conformity Declaration



EU Declaration of Conformity

The product TAE 1244 conforms to the following European directives:

- **2014/35/EU** Low-voltage Directive
- **2014/30/EU** Electromagnetic Compatibility (EMC Directive)
- **2011/65/EU** "Restricted use of certain hazardous substances in electrical and electronic equipment" (RoHS Directive)

The EU Conformity Declarations are provided on the SIGMATEK website. They can be found in the download area of the respective product.

4 Type Plate

	HW: X.XX SW: XX.XX.XXX Safety Version: SXX.XX.XX
Serial No.	SIGMATEK GMBH & CO KG Sigmatekstrasse 1 A-5112 LAMPRECHTSHAUSEN
Article Number	Product Name Short Name

Exemplary nameplate (symbol image)

	HW: 1.00 SW: 01.00.000 Safety Version: S01.00.00
12345678	SIGMATEK GMBH & CO KG Sigmatekstrasse 1 A-5112 LAMPRECHTSHAUSEN
12-246-133-3	Handbediengerät Wireless HGW 1033-3

HW: Hardware version

SW: Software version

5 Technical Data

5.1 Performance Data

Interfaces	1x HMI Remote IN (HMI-Link G2.1) 2x USB 2.0 Type A OUT 1x Panel Interface Connector (for connecting a SIGMATEK TP)
Internal interfaces (via Panel Interface Connector)	USB 2.0 (for touch and front USB, if available on the TP)
Status LEDs	1x green 1x red (depends on OS)
Display Resolution	12.1" color display WXGA 1280 x 800 pixels
Operating field	touch screen (projective capacitive)
Cooling	passive (fanless)

5.2 Electrical Requirements

Supply voltage	+24 V DC $\pm 20\%$ (SELV/PELV) UL: NEC Class 2	
Protection class	III	
Current consumption of (+24 V) power supply	typically 800 mA (with no external devices connected)	maximum 1000 mA (with external devices connected)
Inrush current with 24 V/10 A fixed voltage supply	maximum 3.1 A (for 17 ms, load-dependent)	
Inrush current without current- limiting supply	maximum 76 A (for 1.2 ms, load-dependent)	

INFORMATION



For USA and Canada:

The supply must be limited to:

- a) max. 5 A at voltages from 0-20 V DC, or
- b) 100 W at voltages from 20-60 V DC

The limiting component (e.g. transformer, power supply or fuse) must be certified by an NRTL (Nationally Recognized Testing Laboratory).

5.3 Display

Type	12.1" TN color display
Resolution	WXGA 1280 x 800 pixels
Color depth	18-bit RGB
LCD mode	normally black ¹⁾
LCD Polarizer	transmissive ²⁾
Pixel size	0.204 x 0.204 mm
Active range	261.12 x 163.2 mm
Backlighting	LED
Contrast ratio	typically 1000:1
Brightness	typically 400 cd/m ²
Angle CR ≥ 10	all directions typically 89° ³⁾
Life span	By compliance with the ambient conditions, the brightness of the display sinks after 50,000 operating hours to 50 % of the original brightness.

Due to the manufacturing process, individual pixel errors cannot be excluded to 100 % and therefore do not constitute a reduction in quality.

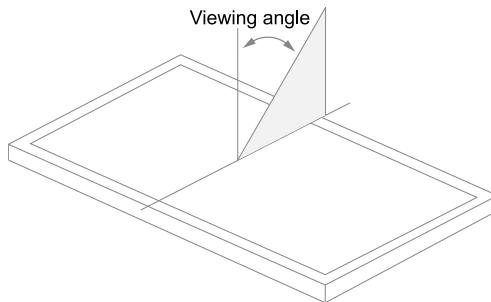

1) If there is no display data, the display is black.

2) Display technology, with which display backlighting is used.

3) The viewing angle is measured from the normal to the display surface.

5.4 Control Unit

Operating field	Touch screen (multi-touch, projective capacitive)
Maximum number of fingers	10
The operation with thin gloves	yes
SIGMATEK Touch pen (passive)	yes
Handwriting recognition	no
Ball of the thumb recognition	no
Water spray recognition ¹⁾	yes
Water detection ²⁾	no
Cleaning	see chapter 12.1 Cleaning and Disinfecting the Touch Screen

INFORMATION



The device must always be grounded or with cable-connected devices, the mass must be connected correctly to ensure stable function of the touch screen. The touch function may still have to be individually adapted to the respective environmental conditions.

¹⁾ Detects individual water droplets on the touch screen and remains operable.

²⁾ Detects a large amount of water on the touch screen and deactivates it.

5.5 Minimum Distance between Operating Elements for Multi-touch Applications

To guarantee smooth operation with multi-touch applications, buttons and control elements that should be operated at the same time must have the minimum clearance shown below (depending on the estimated touch point).

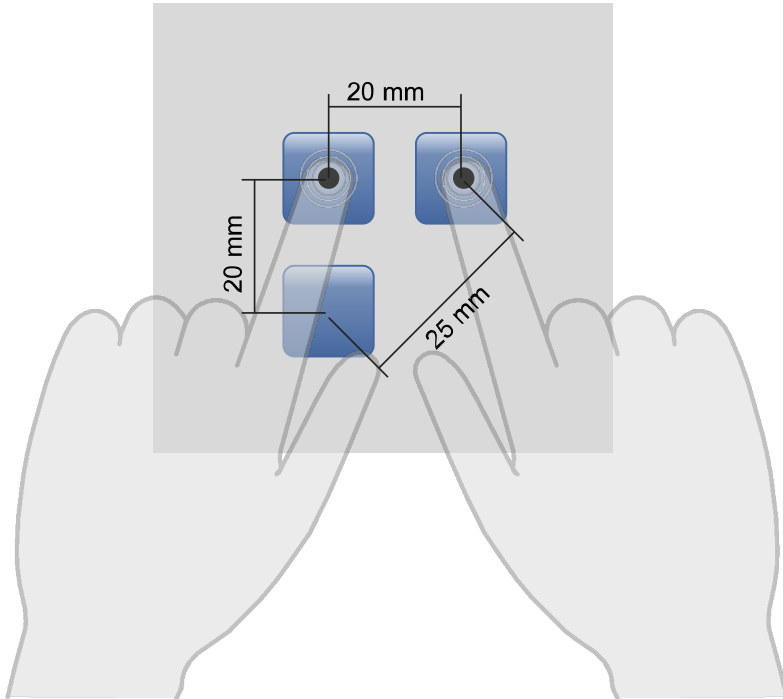

INFORMATION



The size of the buttons and operating elements directly affect the operability of the application. Small operating elements should therefore be avoided.

5.6 Environmental Conditions

Storage temperature	-25 ... +85 °C	
Environmental temperature	0 ... +50 °C ¹⁾	
Humidity	10-95 %, non-condensing	
Installation altitude above sea level	0-2000 m without derating > 2000 m up to a maximum of 5000 m with derating of the maximum environmental temperature by 0.5 °C per 100 m	
Operating conditions	pollution degree 2	
Noise emissions	≤ 70 dB	
EMC resistance ²⁾	EN 61000-6-2 (industrial area) EN 61000-6-1 (residential area)	
EMC noise emission ²⁾	EN 61000-6-4 (industrial area) EN 61000-6-3 (residential area)	
Vibration resistance	EN 60068-2-6	3.5 mm from 5-8.4 Hz 1 g from 8.4-150 Hz
Shock resistance	EN 60068-2-27	15 g (147.15 m/s ²)
Protection type ²⁾	EN 60529	front: IP65 cover: IP20 (not UL-listed)

1) The maximum environmental temperature allowed depends on the TP connected. The ambient temperature cannot exceed any of the permissible values.

2) Applies only if the PIM 021 is mounted onto the TP.

5.7 Miscellaneous

Article number	12-200-1244
Standard	designed according to UL
Approvals	CE

CAUTION



If the modular components (e.g. TP and PIM) are not bolted together, they are NOT ESD-protected and can only be unpacked and handled in an ESD-safe environment by trained personnel.

To avoid damage to the electronics, never handle the circuit board itself without the appropriate ESD protection. It is recommended that any physical contact with the circuit board be avoided (body and/or objects).

6 Interfaces

6.1 Front Connectors

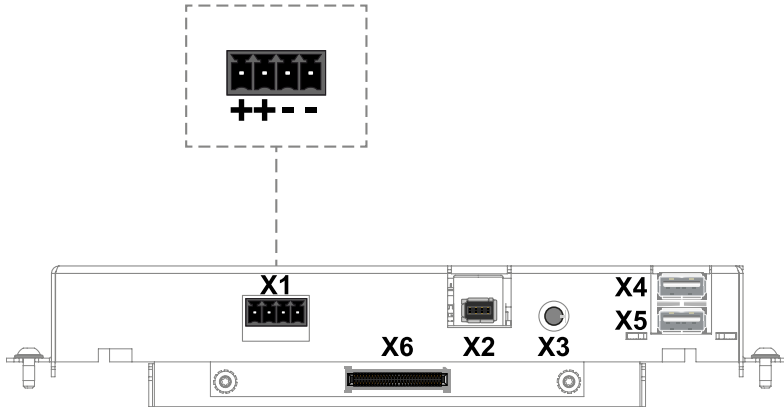

6.1.1 X1: Supply (4-pin Phoenix RM 3.5)

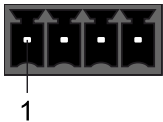

Pin	Function
1	+24 V DC
2	+24 V DC
3	GND
4	GND

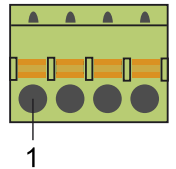

6.1.2 X2: HMI Remote-IN (HMI-Link G2.1, Industrial Mini I/O)

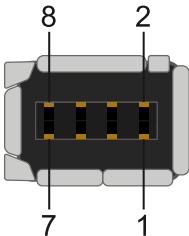

Pin	Function
1	Tx+/DA+
2	Tx-/DA-
3	Rx+/DB+
4	DC+
5	DC-
6	Rx-/DB-
7	DD+
8	DD-

6.1.3 X3: Service



Pin	Function
1	GND
2	TxD
3	RxD
4	n.c.

n.c. = do not use

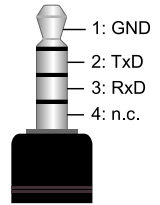

INFORMATION



For service purposed only!

- For the service interface, only a separate cable that can be ordered from SIGMATEK may be used. Using a different cable can lead to malfunction and damage.

6.1.4 X4, X5: USB 2.0 (Type A)

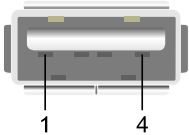

Pin	Function
1	+5 V, $I_{out,max} = 500\text{ mA}$
2	D-
3	D+
4	GND

INFORMATION



It should be noted that many of the USB devices on the market do not comply with USB specifications; this can lead to device malfunctions. This may cause the device to malfunction. It is also possible that these devices will not be detected at the USB port or function correctly. It is therefore recommended that every USB stick or USB supply be tested before actual use.

6.1.5 X6: Panel Interface Connector

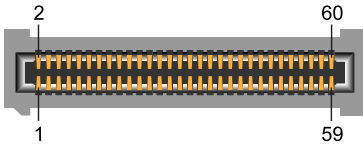

The panel interface connector connects the PIM with the TPs from SIGMATEK.

6.2 Applicable Connectors

- X1:** 4-pin Phoenix plug with spring terminal FK-MCP 1.5/ 4-ST-3.5 (included with delivery)
- X2:** 8-pin Industrial Tyco Mini I/O (not included with delivery)
- X3:** For the service interface, only a separate cable that can be ordered from SIGMATEK may be used. Using a different cable can lead to malfunction and damage.
- X4, X5:** USB 4-pin, Type A (downstream connector) (not included with delivery)
- X6:** Panel Interface Connector (display side)

6.3 Status Display LEDs

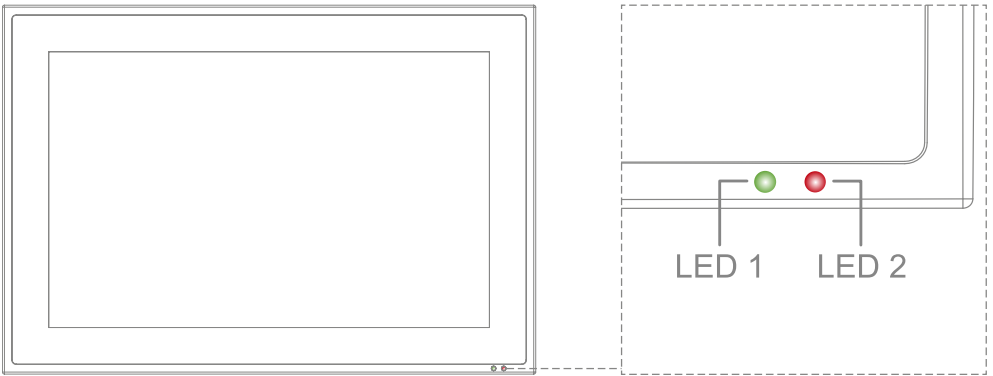

LED	LED Color	Definition
1	green	DC OK
2 (OS dependent)	red	Error

The status LEDs of a PIM with EDGE2, for example, can be controlled via the application. With standard settings within an application or after starting the PIM's operating system, the LEDs respond as follows:

Turning on the supply	DC OK lights green
In the CLI, while processing the autoexec.lsl until the application is running (Salamander OS)	DC OK lights green Error blinks red
While the running the application (Salamander OS)	DC OK lights green Error does not light

7 Mechanical Dimensions

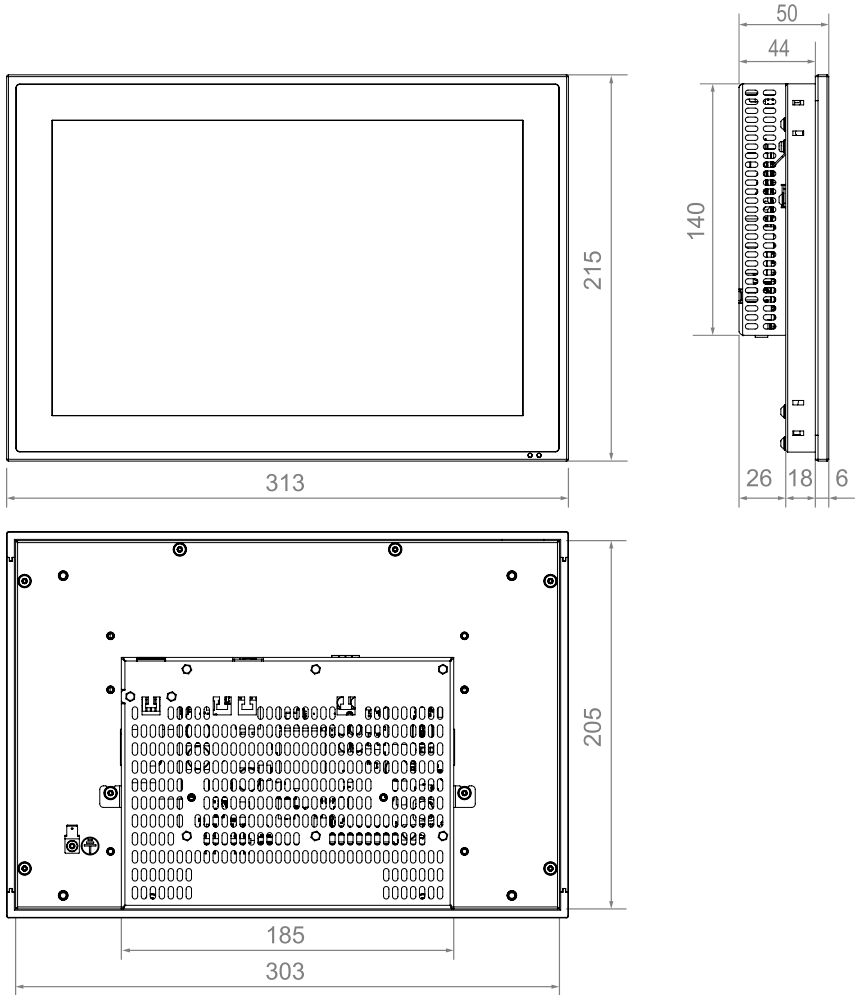

Dimensions	313 x 215 x 50 mm (W x H x D)
Material	Front plate: 1.8 mm glass (touch screen) in black anodized aluminum frame
Weight	2.1 kg

INFORMATION



Due to the aluminum front, caution must be taken to ensure that it is not damaged during mounting via strong impacts on the edges or corners!

8 Assembly/Installation

8.1 Check Contents of Delivery

Ensure that the contents of the delivery are complete and intact. See chapter 1.3 Contents of Delivery.

INFORMATION



On receipt and before initial use, check the device for damage. If the device is damaged, contact our customer service and do not install the device in your system.

Damaged components can disrupt or damage the system.

8.2 Installation

The device's power loss can reach up to 14 Watts. To ensure the necessary air circulation for cooling, the mounting instructions must be followed!

8.3 Mounting Instructions

The following instructions must be followed when installing the terminal:

- For installation with the screw terminals provided, it is recommended that the installation panel have a material strength of at least 1 mm and a maximum of 2 mm. The screw-in brackets can be tightened with a torque of 0.15-0.2 Nm. For this purpose, a 3x 0.5 flat-tip screw driver is required.
- To avoid damage to the aluminum frame, it is important to ensure that during installation, the contact surface is clean (free of debris, uneven areas). Unevenness can lead to stress on the glass/aluminum frame or contamination from dust and water.
- To minimize the probability of damage to the PIM or plug contacts of the TP during installation, we recommend installing the TP after the PIM has been mounted.

To dissipate waste heat from the terminal, the clearance between the back of the terminal (heat sink) and the back wall of the control cabinet should be at least 80 mm.

8.3.1 Restricted Space Around Rear Trimming

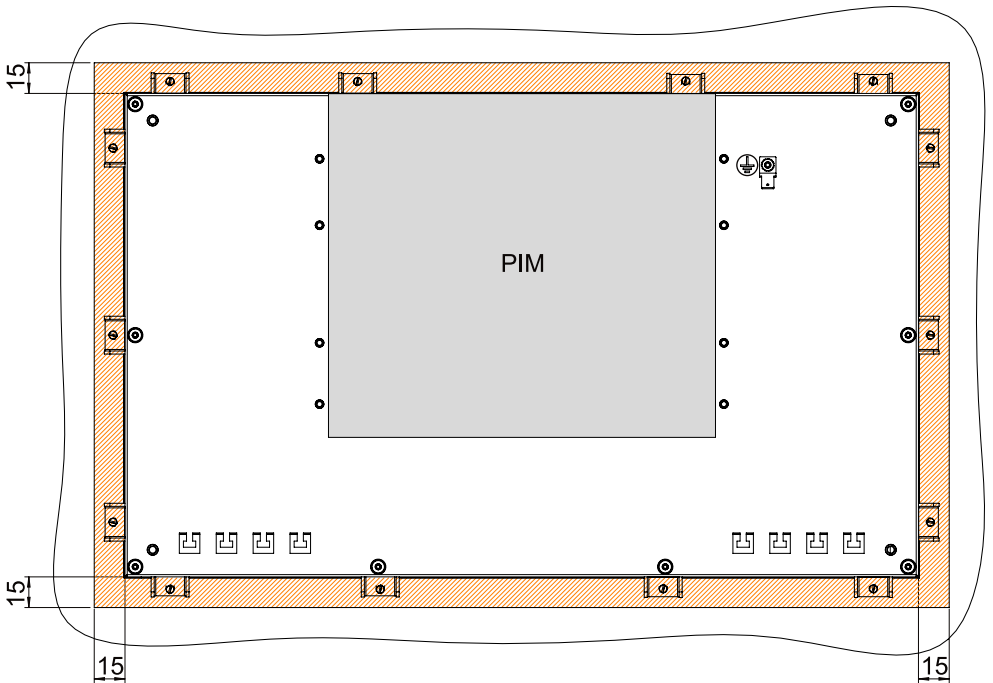

Symbol Image 15"

A restricted area of 15 mm around the terminal must be ensured. This is required to exchange the module without removing the TP, tightening the screw terminals and ensuring cooling of the TP.

8.3.2 Required Cutout for Mounting the Terminal

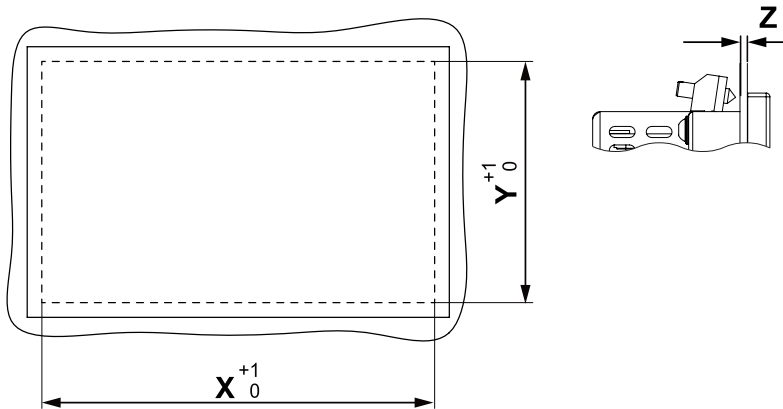

Control cabinet cutout width X	304 mm
Control cabinet cutout height Y	206 mm
Maximum thickness of control cabinet wall Z	3 mm

8.3.3 Mounting Position

Observe the mounting position of 60-120°.

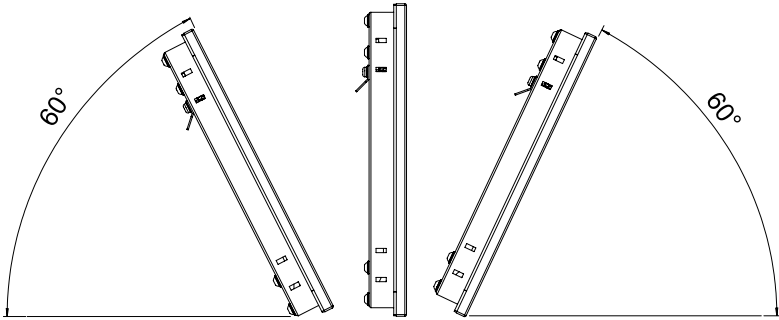

INFORMATION



The specified installation distances may be reduced if appropriate measures and technical precautions are taken to dissipate the corresponding waste heat.

9 Wiring

9.1 Grounding

The TAE 1244 is grounded via the TP. The device must be grounded to protective earth (PE) via the blade terminal provided. In addition, ensure that when installing into the control cabinet, a large grounding surface is provided. It is important to establish a low-Ohm connection to ground to ensure error-free function. The ground connection must be made with the maximum wire cross-section and largest (electrical) surface possible. The cable length of the ground connection must also be kept as short as possible.

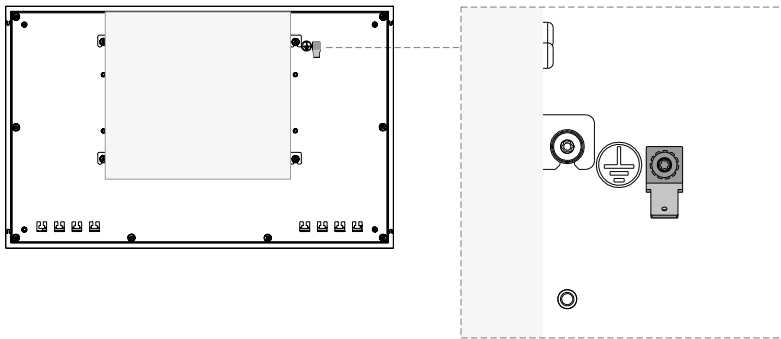

Symbol Image 15“

INFORMATION



The wiring instructions for the respective TPs used must also be followed.

9.2 Shielding

For Ethernet, CAT5e (STP - Shielded Twisted Pair) cables are recommended. The cable shielding is connected to ground via the connector. Noise signals can then be prevented from reaching the electronics and affecting the function.

9.3 ESD Protection

CAUTION

The operator must ensure that no ESD interference affects the product.

L'opérateur doit s'assurer qu'aucune interférence due à des décharges électrostatiques n'affecte le produit.

9.4 USB Interface

The product has a USB interface. This interface can be used to connect various USB devices (keyboard, mouse, storage media, hubs, etc.). Several USB devices can be connected using a hub, which are then fully functional.

10 Transport/Storage

INFORMATION



This device contains sensitive electronics. During transport and storage, high mechanical stress must therefore be avoided.

For storage and transport, the same values for humidity and vibration as for operation must be maintained!

Temperature and humidity fluctuations may occur during transport. Ensure that no moisture condenses in or on the device, by allowing the device to acclimate to the room temperature while turned off.

When sent, the device should be transported in the original packaging if possible. Otherwise, packaging should be selected that sufficiently protects the product from external mechanical influences. Such as cardboard filled with air cushioning.

11 Storage

INFORMATION



When not in use, store the device according to the storage conditions. See chapter 10 Transport/Storage.

During storage, ensure that all protective covers (if available) are placed correctly, so that no contamination, foreign bodies or fluids enter the device.

12 Maintenance

INFORMATION



During maintenance as well as servicing, observe the safety instructions from chapter 2 Basic Safety Directives.

Lors de l'entretien et de la maintenance, respectez les consignes de sécurité du chapitre 2 Basic Safety Directives.

12.1 Cleaning and Disinfecting the Touch Screen

CAUTION



Before cleaning and disinfecting the touch screen, it must first be deactivated; either by turning off the terminal or by disabling the touch screen via the application to avoid unintentionally activating functions or commands!

Avant de nettoyer et de désinfecter l'écran tactile, il faut d'abord le désactiver; soit en éteignant le terminal, soit en désactivant l'écran tactile via l'application pour éviter d'activer involontairement des fonctions ou des commandes!

The touch screen can only be cleaned with a soft, damp cloth. To dampen the cloth, a mild cleaning solution such as antistatic foam cleaner is recommended. To avoid fluids/cleaning solutions from getting into the housing, the device must not be sprayed directly. To clean, no erosive cleaning solutions, chemicals, abrasive cleansers or hard objects that can scratch or damage the touch screen may be used. The use of steam jets or compressed air is prohibited.

For disinfection, surface disinfectants on alcohol basis, which do not contain re-fattening agents, can be used. The disinfectant used must not leave any residues on the touch screen to ensure proper functioning of the touch screen.

WARNING

If the device is contaminated with toxic or erosive chemicals, it must be carefully cleaned as quickly as possible to prevent personal injury and machine damage!

Si l'appareil est contaminé par des produits chimiques toxiques ou érosifs, il doit être soigneusement nettoyé le plus rapidement possible afin d'éviter des dommages corporels et matériels!

INFORMATION

To ensure the optimal function of the device, the touch screen should be cleaned at regular intervals!

12.2 Service

This product was constructed for low-maintenance operation.

12.2.1 Calibrating the Touch Screen

The touch screen is calibrated at the factory. You should therefore only recalibrate the touch screen when press-point changes are noticed.

12.3 Repair

INFORMATION

In the event of a defect/repair, send the device with a detailed error description to the address listed at the beginning of this document. For transport conditions, see chapter 10 Transport/Storage.

12.4 Position Series Label Sub Device

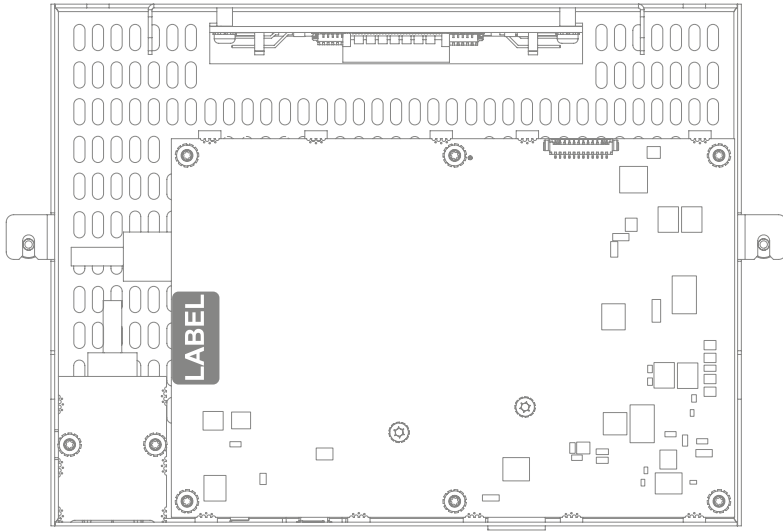

13 Modularity

INFORMATION



The device is not Hot-Plug capable and can be damaged when the supply is not disconnected before inserting or removing the PIM.

→ Always disconnect the supply before inserting or removing.

13.1 Removing the PIM from the Touch Panel

CAUTION



This product is a sensitive electronic device. When mounting, as well as dismantling, note that you come into contact with ESD-sensitive areas of the device.

→ The applicable ESD measures must be taken!

To remove a PIM from a TP, follow the steps below:

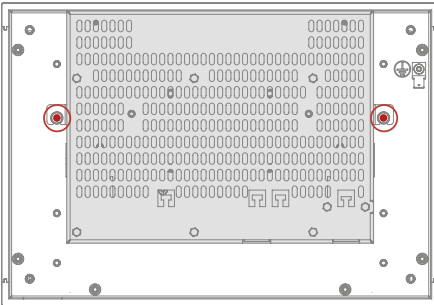

1. Ensure that an ESD-compliant working method is followed (ESD armband, ESD clothing).
2. Disconnect the device from the supply.
3. Place the TP flat on its back.
4. Loosen the 2 screws with a TX10 screwdriver.

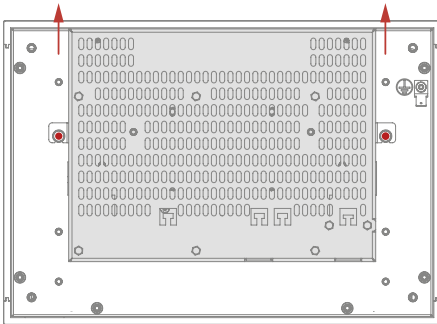

5. Slide the PIM in the direction of the upward as shown.
6. Remove the PIM from the TP.

13.2 Mounting the PIM onto the Touch Panel

To mount the PIM on a TP, follow the steps below:

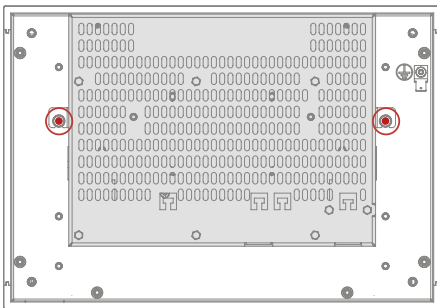
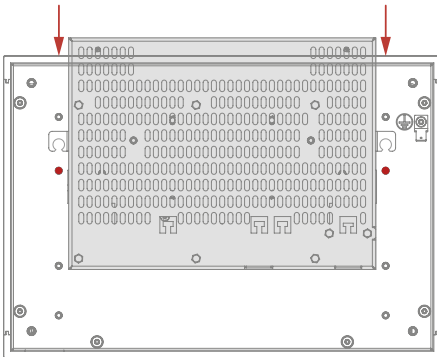

1. Ensure that an ESD-compliant working method is followed (ESD armband, ESD clothing).
2. Disconnect the device from the supply.
3. Place the TP flat on its back.
4. Place the PIM onto the TP so that the locking clamps of the PIM are securely held in the notches of the TP.
5. Slide the PIM in the direction of the arrows shown.
6. When locking, a “click” can be clearly heard and the thin upper section of the PIM is flush with the housing of the TP.
7. Secure the PIM to the TP using the 2 screws provided and a TX-10 Torx screwdriver with a torque of 0.7 Nm.

14 Display „Burn-In“ Effect

The “Burn-In” effect describes a pattern burned into the display after displaying the same contents over a longer period of time (e.g. a single screen).

This effect is also described mostly as “image sticking”, “memory effect/sticking” or “ghost image”.

Here, a distinction is made between a temporary and permanent effect, while the temporary effect is eliminated by switching off the screen for a longer period of time or by displaying dynamic content, serious cases of burn-in can lead to permanent damage to the display.

This effect can have the following causes:

- Operation without a screen saver
- The same contents displayed over a longer time period (e.g. a single screen)
- Operation at high environmental temperatures
- Operation above specifications

The effect can be avoided/reduced by the following actions:

- Using a screen saver
- Deactivating the display when not in use (e.g. screen display black)
- Continuously changing screen content (e.g. video)

INFORMATION



Deactivating the display backlighting only does not prevent Burn-In!

15 Disposal



INFORMATION

Should you need to dispose of the device, the national regulations for disposal must be followed.

The device appliance must not be disposed of as household waste.



16 Accessories

16.1 Touch Pen



Description	Order Number
Touch pen with holder V3	01-690-059-3

Changes Chart

Change date	Affected page(s)	Chapter	Note
30.07.2020	34	12.1 Cleaning and Disinfecting the Touch Screen	Notes on disinfection added
20.08.2020	36	12.4 Position Series Label Sub Device	Chapter added
31.08.2020	1	Introduction	Text corrected
	20	6.1 Front Connectors	X9 => X6
08.09.2020	18	5.6 Environmental Conditions	Protection type front added
09.09.2020	Document		Restructuring
11.11.2020	24	7 Mechanical Dimensions	more details
22.02.2021	26	8.3 Mounting Instructions	Tightening torque more detailed
05.03.2021	15	5.3 Display	Graphic added
28.04.2021	16	5.4 Control Unit	Chapter extended
25.03.2024	Document		Layout
13.08.2024	Document		Designation display information