

## VARAN Splitter PROFINET

## VSP 045

With its 3 VARAN Out ports, the VARAN VSP 045 splitter module allows a VARAN bus system to be configured in a tree structure.

The VARAN Out ports have a +24 V supply for the VARAN bus, which can be switched via the software.

With this supply, special VARAN peripheral devices can be connected to the VSP 045 and supplied with +24 V without an additional power cable.

At the Ethernet port(IP), incoming Ethernet packets are – similar to using a HUB – distributed to all other Ethernet ports in the VARAN bus system and the VARAN Manager (and therewith the CPU) using VtE.

In addition, the VSP 045 has an integrated PROFINET Sinamics Gateway for integrating a Siemens servo amplifier (Sinamics S120) into the VARAN system.



until HW 1.x



since HW 2.x

## Technical Data

### Performance Data

Interfaces	<p>1 x VARAN In (RJ45)  1 x ETHERNET Port VtE (RJ45) 10/100Mbit  3 x VARAN-Out (RJ45) +24 V supply switchable over VARAN  1 x PROFINET Sinamics Gateway (RJ45)</p> <p>(maximum cable length: 100 m)</p>
Internal data memory (SPI-Flash)	4 Mbits

### Electrical Requirements

Supply voltage	18 – 30 V DC
Supply voltage (UL)	18 – 30 V DC (Class 2)
Current consumption of voltage supply	<p>The current consumption is dependent on the connected loads</p> <p>(200 mA module + 3 x VARAN Out 500 mA per port) (until HW 1.x)  (120 mA module + 3 x VARAN Out 500 mA per port) (since HW 2.x)</p>
Current consumption of the power supply (UL)	114 mA + 3 x 500 mA maximum (24 V DC)

**Designed exclusively for connection to a galvanically separated supply with a rated voltage of 24 V DC. In compliance with UL248, the Fuse must be connected in the area between the supply source and the module!**

### Miscellaneous

Article number	16-023-045
Hardware version	1.x, 2.x
Standard	UL508 – E247993:

**Environmental Conditions**

Storage temperature	-20 – +85 °C	
Environmental temperature	0 –+60 °C	
Humidity	0 – 95 %, non-condensing	
EMC stability *)	in accordance with EN 61000-6-2 (industrial area)	
EMC noise generation	in accordance with EN 61000-6-4 (industrial area)	
Shock resistance	EN 60068-2-27	150 m/s <sup>2</sup>
Protection type	EN 60529	IP 20
Protection Type (UL)	open type device	
Pollution degree	2	

\*) Control box mounting required

### Mechanical Dimensions until HW 1.x

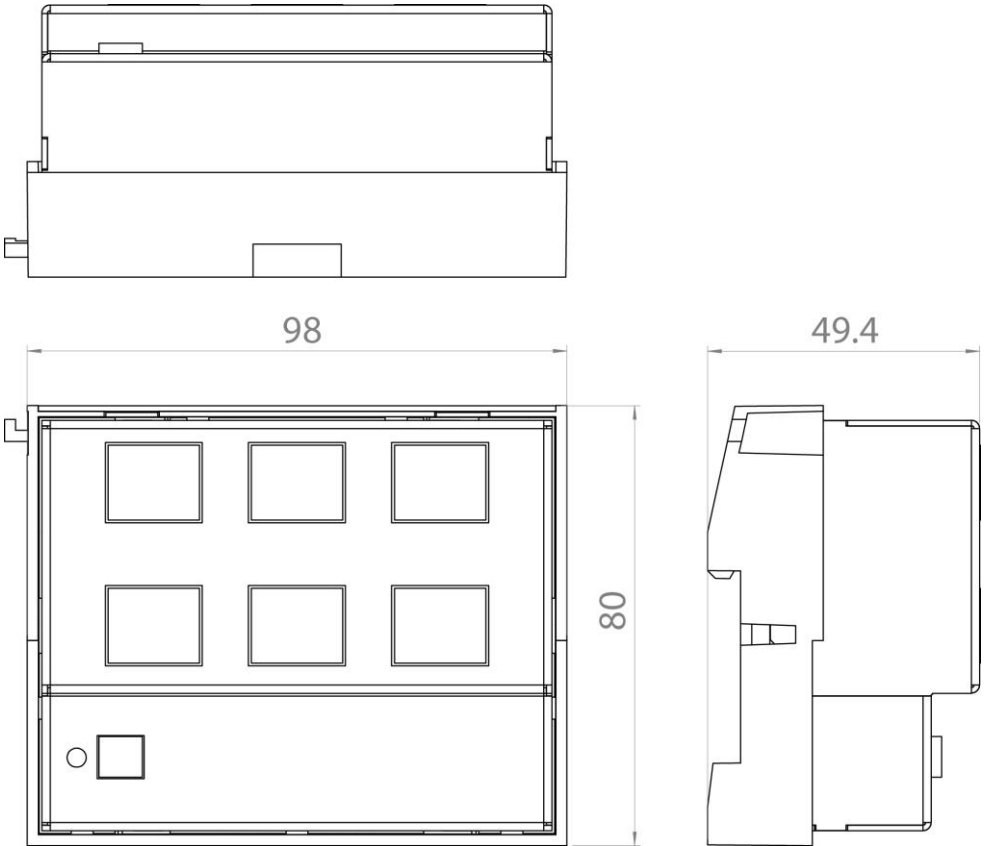

**Mechanical Dimensions since HW 2.x**

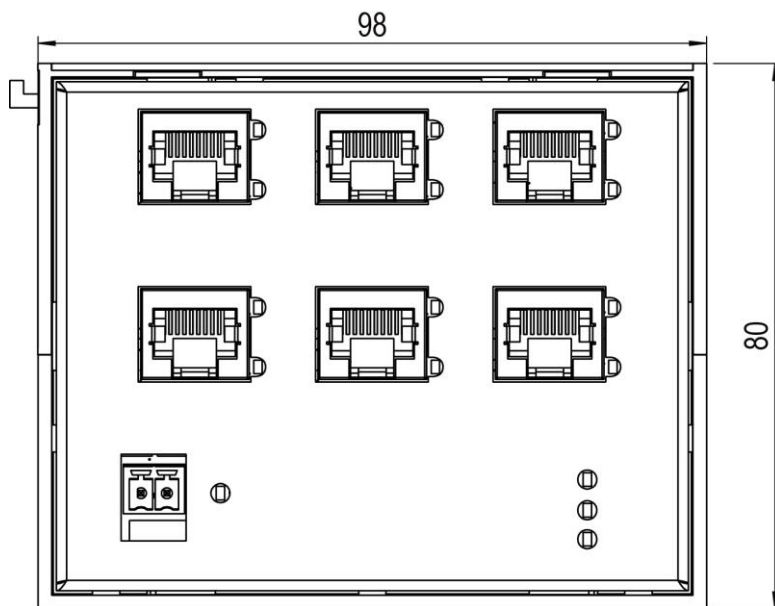
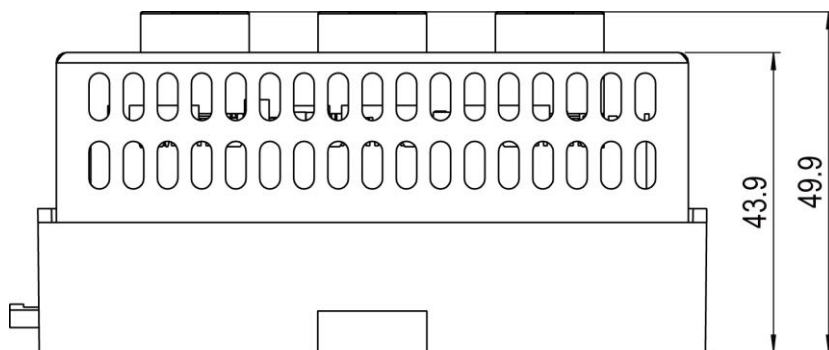

# Connector Layout

## Connector Layout until HW 1.x

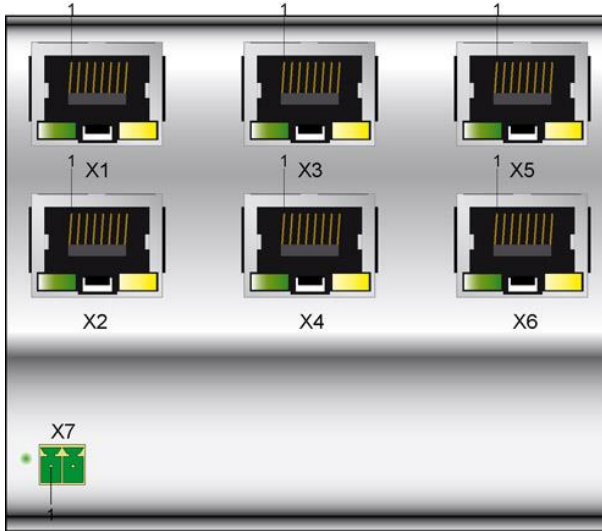

## Connector Layout since HW 2.x

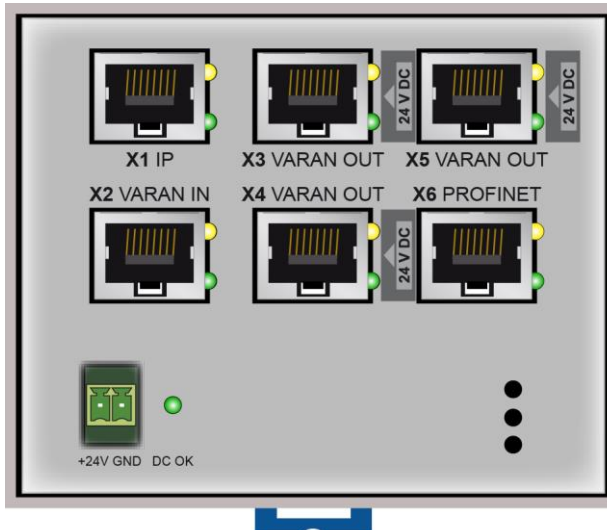

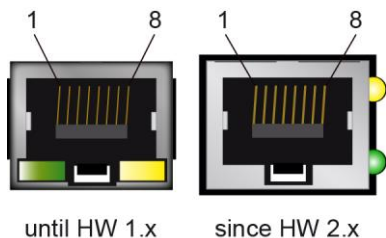
**X1: ETHERNET Port VtE (IP)**

Pin	Function
1	TX/RX +
2	TX/RX -
3	RX/TX +
4 - 5	not connected
6	RX/TX -
7 - 8	GND

LEDs	Function
Yellow	ACTIVE
Green	LINK

LED	Color	Description
ACTIVE	Yellow	Lights when data is exchanged over Ethernet.
Link	Green	Lights when the connection between the both PHYs is established.
	Green	Blinks when date is received over Ethernet.

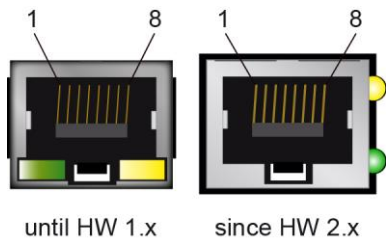
**X2: VARAN In**

Pin	Function
1	TX/RX +
2	TX/RX -
3	RX/TX +
4 - 5	not connected
6	RX/TX -
7 - 8	GND

LEDs	Function
Yellow	ACTIVE
Green	LINK

LED	Color	Description
ACTIVE	Yellow	Lights when data is exchanged over the VARAN bus.
Link	Green	Lights when the connection between the both PHYs is established.
	Green	Blinks when data is received over the VARAN bus

### X3 – X5: VARAN Out 1 – 3

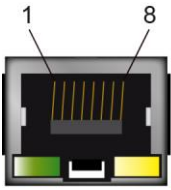

until HW 1.x

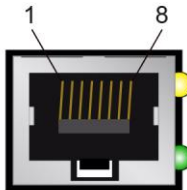

since HW 2.x

Pin	Function
1	TX/RX +
2	TX/RX -
3	RX/TX +
4 - 5	+24 V-Out
6	RX/TX -
7 - 8	GND

LEDs	Function
Yellow	ACTIVE
Green	LINK

LED	Color	Description
ACTIVE	Yellow	Lights when data is exchanged over the VARAN bus.
Link	Green	Lights when the connection between the both PHYs is established.
	Green	Blinks when data is received over the VARAN bus

#### 24 V / 500 mA per VARAN Out port (switchable)

Since the components are supplied with power through VARAN, the maximum cable length (without new +24 V supply) is highly dependent on the cross section of the VARAN cable and the number of connected modules.

The voltage can be supplied (switchable via the software) to the following modules over the RJ45 connector of the VARAN Out port.

**This does NOT comply with the VARAN specification.**

The supply voltage of the VARAN Out port to the module can only then be turned on when the respective port is connected to a VARAN module that is suited of a +24 V supply (e.g.: VDM 085, PVDM 08x, PVAI 011, VEB 02x, .....).

#### CAUTION!

**VARAN modules, which are not suitable for the supply over VARAN, can be damaged when connected to modules with an active power supply.**

**More information on the VARAN bus can be found in the VARAN bus specifications!**

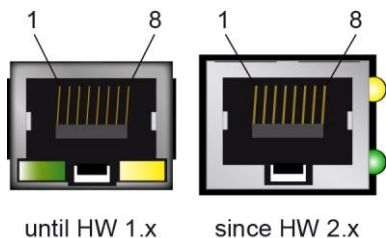

**X6: PROFINET Sinamics Gateway**

Pin	Function
1	TX/RX +
2	TX/RX -
3	RX/TX +
4 - 5	not connected
6	RX/TX -
7 - 8	GND

LEDs	Function
Yellow	ACTIVE
Green	LINK

**When using the PROFINET Sinamics Gateway ports only a 4-wire Industrial Ethernet bus connection may be used, which uses the Rx- and Tx-wires on the PINs 1, 2, 3 and 6 of the RJ45, otherwise there might be a damage on the PROFINET Sinamics receiver.**

LED	Color	Description
ACTIVE	Yellow	Lights when data is exchanged over the PROFINET port.
Link	Green	Lights when the connection between the both PHYs is established.
	Green	Blinks when data is received over the PROFINET port.

## X7: Power Plug



1

Pin	Function
1	+24 V supply
2	GND



1

Connectors	Type	Wire Size	Max. Tightening Torque
X1-6	RJ 45	-	-
X7	FK-MCP1.5/2-ST-3.5	0.14 - 1.5 mm <sup>2</sup> 28 - 16 AWG (UL/cUL)	Spring terminal

## Applicable Connectors

### Connectors with spring terminals:

Phoenix Contact: FK-MCP 1.5/ 2-ST-3.5

The complete C-DIAS CKL 141 connector set with spring terminals is available from SIGMATEK under the article number 12-600-141.

## Addressing

**More information on the VARAN bus can be found in the VARAN bus specifications!**

## Description of PROFINET Sinamics Gateway

The Profinet port of the VSP 045 is used to integrate a Siemens Sinamics S120 servo amplifier into the VARAN system.

A point-to-point Profinet connection between the VSP 045 and the Sinamics S120 is thereby made.

Other Profinet participants cannot be connected.

For the Sinamics S120 servo amplifier, a special Firmware is required.

## Recommended Shielding for VARAN

The VARAN real-time Ethernet bus system exhibits a very robust quality in harsh industrial environments. Through the use of IEEE 802.3 standard Ethernet physics, the potentials between an Ethernet line and sending/receiving components are separated. In the event of an error, the VARAN Manager resends messages to a bus participant immediately. The shielding described below is mainly recommended.

For applications in which the bus is operated outside the control cabinet, the correct shielding is required. This is especially important, if due to physical requirements, the bus cables must be placed next to sources of strong electromagnetic noise. It is recommended to avoid placing VARAN bus lines parallel to power cables whenever possible.

SIGMATEK recommends the use of CAT5e industrial Ethernet bus cables.

An S-FTP cable should be used for the shielding. An S-FTP bus is a symmetric, multi-wire cable with unshielded pairs. For the entire shielding, a combination of foil and braiding is used. A non-laminated variant is recommended.

**The VARAN cable must be secured at a distance of 20 cm from the connector for protection against vibration!**

## 1. Wiring from the Control Cabinet to an External VARAN component

If the Ethernet lines are connected from a VARAN component to a VARAN node located outside the control cabinet, the shielding should be placed at the entry point of the control cabinet housing. All noise can then be deflected from the electronic components before reaching the module.

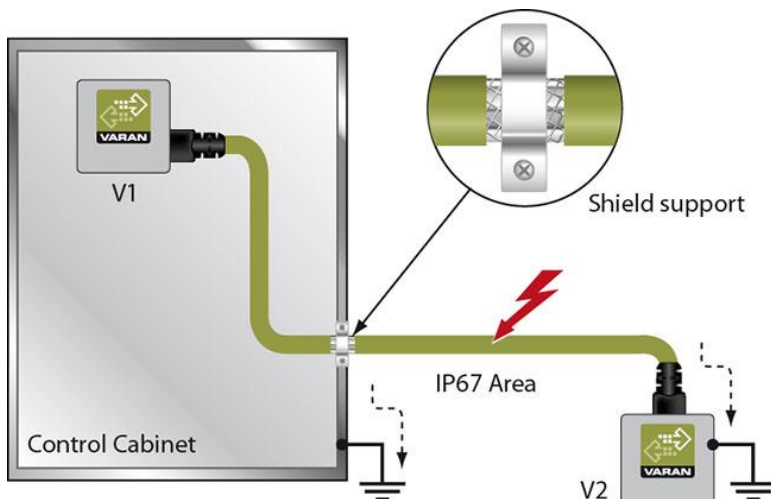

## 2. Wiring Outside of the Control Cabinet

If a VARAN bus line must be connected outside of the control cabinet only, no additional shield support is required. A requirement therefore, is that only IP67 modules and connectors can be used outside the control cabinet. These components are very robust and noise resistant. The shielding for all sockets in IP67 modules are electrically connected internally or over the housing, whereby voltage spikes are not dissipated through the electronics.

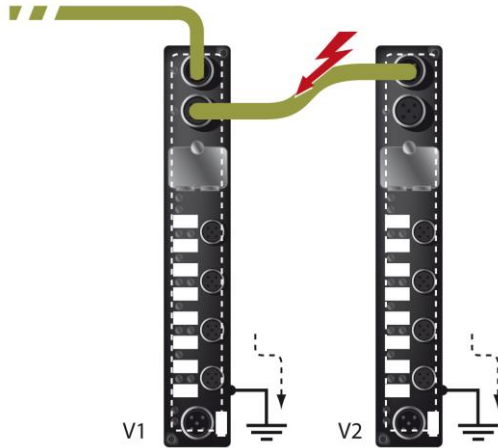

### 3. Shielding for Wiring within the Control Cabinet

Sources of strong electromagnetic noise located within the control cabinet (drives, Transformers, etc.) can induce interference in a VARAN bus line. Spike voltages are dissipated over the metallic housing of a RJ45 connector. Noise is conducted through the control cabinet housing without further action from the electronic components. To eliminate sources of noise during data exchange, it is recommended that the shielding for all electronic components be connected within the control cabinet.

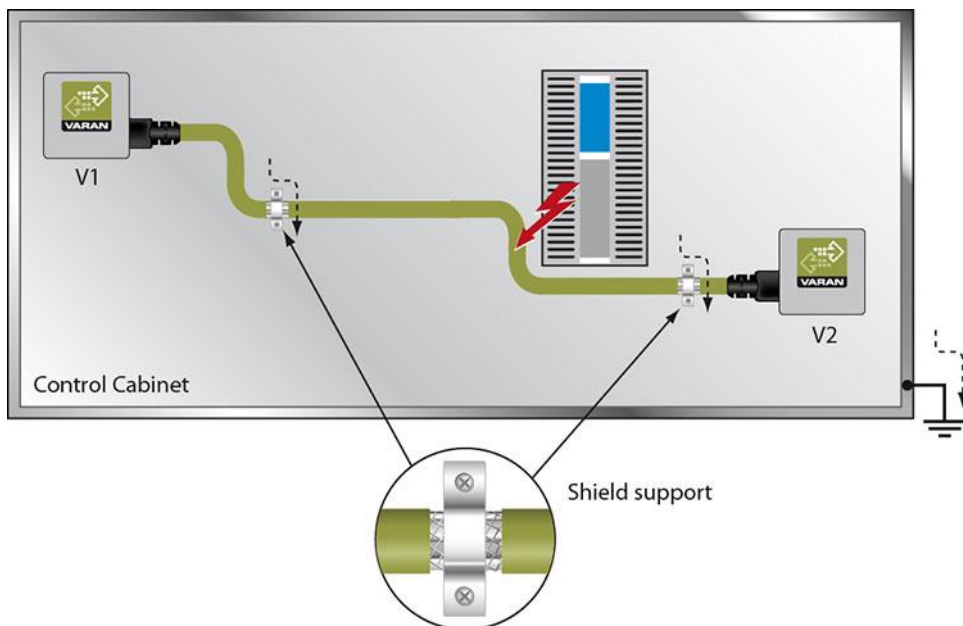

## 4. Connecting Noise-Generating Components

With the connection of power components, which generate strong electromagnetic interference, it is also critical to ensure correct shielding. The shielding should be placed before a power element (or group of power elements).

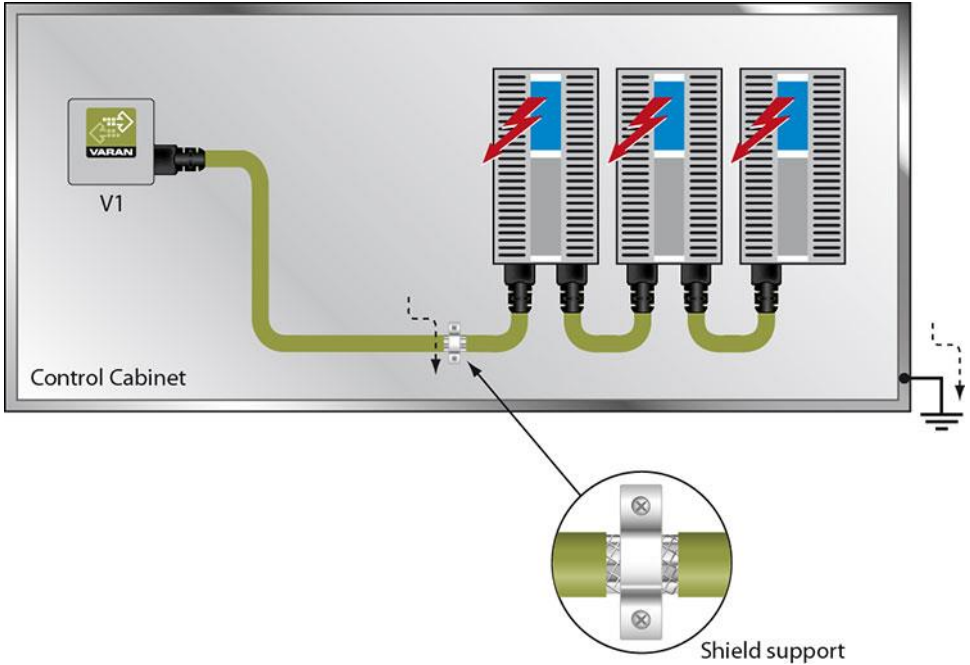



## 5. Shielding Between Two Control Cabinets

If two control cabinets must be connected over a VARAN bus, it is recommended that the shielding be located at the entry points of both cabinets. Noise can be thereby stopped from reaching the electronics within the control cabinet.

